

Processing of BRECO®- and BRECOFLEX® timing belts

Coating materials. Mechanical rework. Welded on profiles.

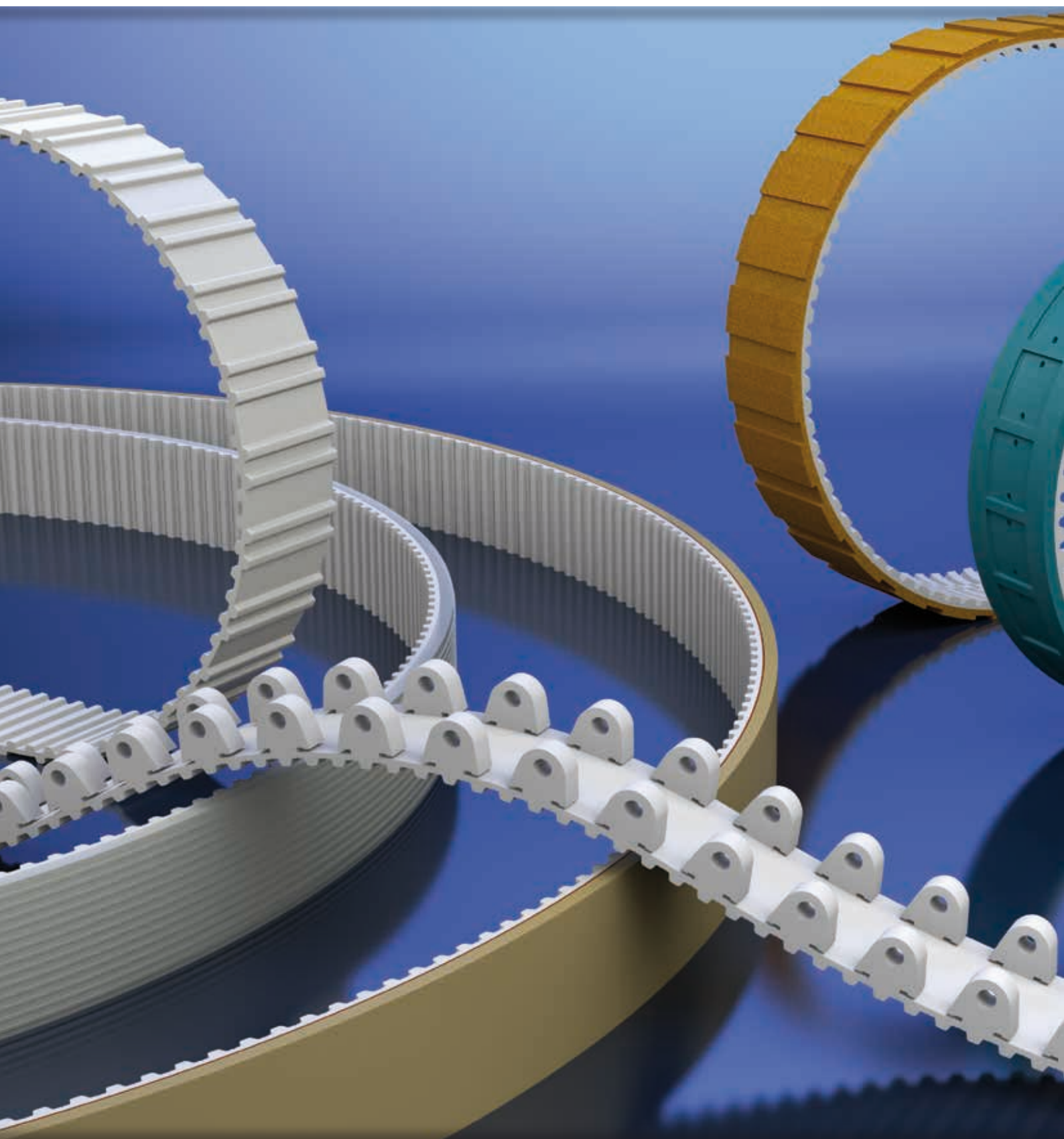

BRECO is member of Mulco Europe EWIV





Keeping things moving!

Innovation is what drives us. As the manufacturer of BRECO® and BRECOFLEX® timing belts, BRECO Antriebstechnik Breher GmbH & Co. KG is the world's most innovative producer in the field of polyurethane timing belt technology. Abrasion-resistant polyurethane for belt bodies and high-strength steel cord tension carriers form the basis of a reliable, first-class product.

As a result of years of experience in working with thermoplastic polyurethane, the development of the BRECO® and BRECOFLEX® production processes and their use, the BRECO name has become synonymous with polyurethane timing belts. The results of the decades of experience gained by countless users of the products are reflected in the BRECO® and BRECOFLEX® timing belts, as well as the toothed pulleys optimised for use with the belts and various other components made by BRECO. The consistent use of nothing but high grade raw materials and our intensive coordination with our suppliers to meet the needs of our customers guarantee extremely high quality.

One focal point is the development and production of special belts for a wide range of applications. The large number of belt coatings and diverse flight shapes allow an extremely broad range of uses for BRECO® and BRECOFLEX® timing belts. We offer several belt and tension carrier materials to cater for applications in very cold or very hot environments, for example.

But even for simple applications, BRECO timing belts offer all the advantages and quality expected of a high-end branded product. Safety, durability, accuracy and availability are some of the benefits that ultimately have a positive impact on costs too.

All of our products conform to the European RoHS Directive, which restricts the use of hazardous substances.

Staying safely on the move.

Table of Contents

Page

General information 6

Coatings for general transport tasks

T version (extruded).....	8
PU 385.....	8
HV film.....	8
T-groove (TR1 and TR2).....	9
WM 385.....	9
NP 385.....	9
FG 385.....	10
PU 60.....	10
Polythane D15.....	10
PU yellow.....	11
PU grey.....	11
Celloflex.....	11
Hamid.....	12
Linatex HM.....	12
RP 430.....	12
Correx.....	13
Sylomer brown.....	13
Sylomer yellow.....	13
Sylomer blue.....	14
Sylomer green.....	14
Sylomer red.....	14
Sylomer grey.....	15
Sylodyn green.....	15
Sylodyn yellow.....	15
Supergrip green.....	16
Supergrip blue.....	16
Minigrip green.....	16
Minigrip blue.....	17
PVC film blue.....	17
Porol.....	17
NBR 65.....	18

Coatings for transporting food

Linaplus FG FDA.....	19
PVC herringbone FDA.....	19
HV film FDA.....	19
PVC film white FDA.....	20
PVC dots white FDA.....	20
Supergrip FDA.....	20

Coatings with friction-reducing properties

PAZ.....	21
PAR.....	21
PAZ-PAR.....	21

Coatings for use at higher contact temperatures

Page

Linatrilite.....	22
TT 60.....	22
Viton.....	22
Chrome leather.....	23
Linard 60.....	23

Coatings with electrically conductive properties

PA fabric, antistatic.....	23
----------------------------	----

Processing of coatings

Mechanical processing.....	24
----------------------------	----

Processing of timing belts

Milling, drilling, stamping, grinding.....	26
Water jet cutting.....	28

BRECO®- and BRECOFLEX® timing belts with welded on profiles

Variety of uses.....	31
Construction features.....	32
Selection of standard profiles.....	37

BRECO® timing belt with high-strength and removable profile connection

Description.....	40
------------------	----

General information

Support rail.....	42
Distribution partner.....	44
Product catalogues.....	46



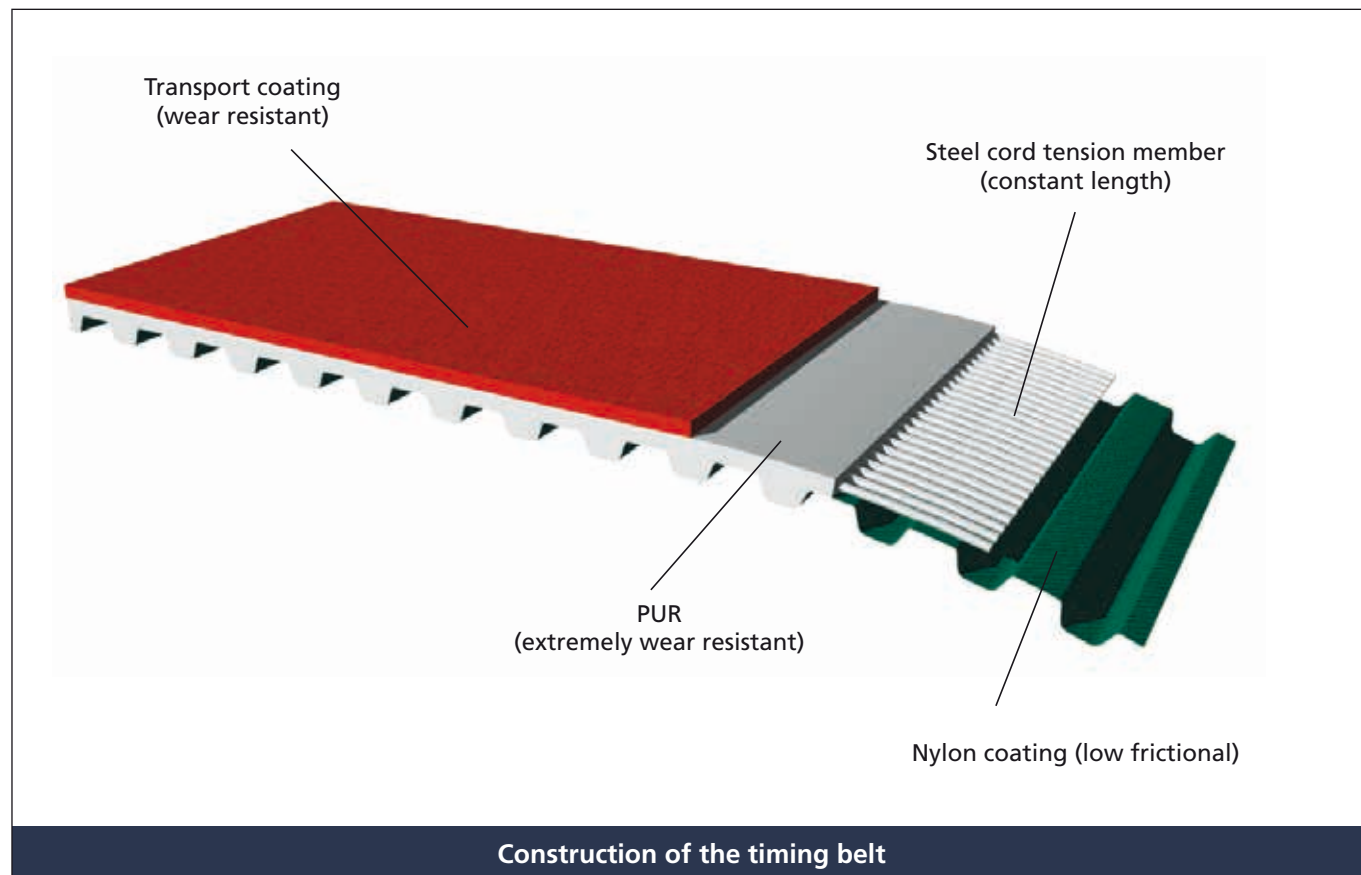

Coated polyurethane timing belts

BRECO® and BRECOFLEX® timing belts consist of wear resistant polyurethane (PUR) and high tensile steel cord tension members. The coating of the timing belts with various materials provides a variety of application possibilities in the transport technology.

The selection of the correct coating depends on the transport item properties and the required grip. High friction for a good carrying effect, low friction to reduce the power transmission performance, soft for sensitive items or hard for sharp-edged items are the determining factors.

Every material involved assumes its task according to its specific property.

To meet specific transport applications, the tooth side and/or the transport side can be mechanically reworked. In this manner, the flexibility of the entire belt can be restored by making incisions in thick coatings.

Coated polyurethane timing belts

Resistance

Depending on the application the resistance of each material part of the coated timing belt is to be viewed separately. The material resistance depends, among others, on the pH value, the concentration, the temperature and the influencing time of the medium. Simple oils generally have no damaging effect on the belt. Additives in the oil and temperatures over approx. 40°C can reduce the longevity.

Friction

The friction of the belt on a support produces heat. This increases the more the belt is loaded by the items to be transported. The bed support must be selected such that the friction value of the transport belt in contact with the material of the bed plate results in a minimum value. The bed plate should guarantee good heat dissipation under high pressure forces.

The friction value changes temperature dependent. It increases as the temperature rises and reduces at temperatures below zero (frost).

Information

You should ask for advice for coatings over 75 mm wide and approx. 2 mm thick because of the different processing properties.

Drives with counter-bending

Coated timing belts are generally suitable for drives with counter-bending. For this, very soft coatings (e.g. Sylomer) should be set up with reduced pretensioning.

Coatings that are manufactured based on natural rubber, such as Linatex, can be used for counter-bending (back pulleys) only to a limited extent. Please consult our technical advice service for this.

Temperature effect / synchronising pulley diameter

When transporting hot goods (above approx. 80°C) it must be ensured that the duration of contact is as short as possible, to avoid heating the belt's substructure to over 80°C. Over a short distance, or for a short time, a coated belt can withstand higher thermal stress, as long as sufficient cooling is provided in the remaining revolution period.

In the temperature range from approx. 60°C the tooth shear strength reduces slightly. An additional safety measure is only needed if the teeth are subjected to major stress.

At low ambient temperatures, the flexibility of the coating reduces. Larger diameters for the synchronised pulleys should therefore be selected than at normal temperatures (see diagram). The flexibility of the timing belt also reduces at low temperatures.

The minimum diameters serve as a guideline. They apply at an ambient temperature of 20°C and speed of 1 m/s, and assuming a low burden from the transported goods. If the exact usage details are known, it is possible to reduce the diameters. Our sales partners will be happy to help you.

The minimum pulley diameters stated in the following tables for the different coatings apply for homogeneously applied coatings with an even thickness. Interruptions in the coating, e.g. due to cuts or grooves, cause significant notch effects and require considerably higher minimum diameters. Our sales partner can advise you on this issue.

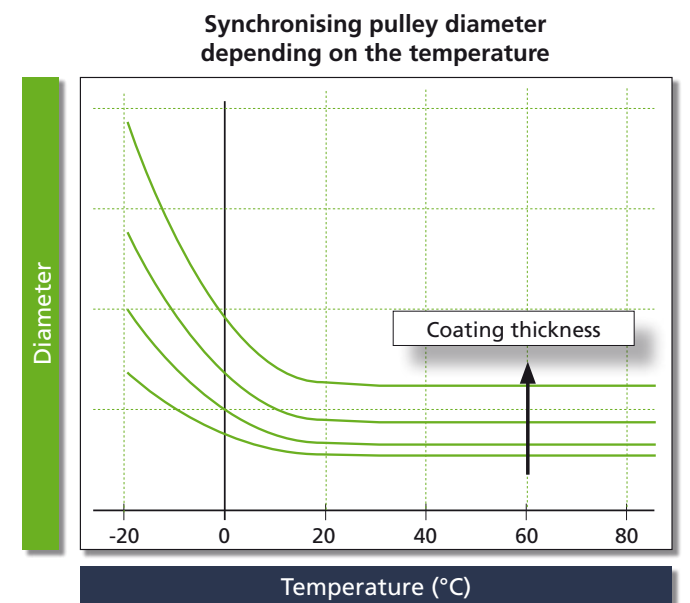

(glass, wood, metal, paper, textiles, cardboard packaging, wet area)



T version (extruded)

Properties		
Colour	transparent	
Standard thickness [mm]	1,5 (5 mm pitch)	2 (Pitch 10, 15, 20, inch pitch)
Min. pulley diameter [mm]	80	80
Material / Hardness	polyurethane/approx. 85 Shore A	
Tolerances	tolerance for total thickness (timing belt + coating) ± 0,4 mm (grinded ±0,1 mm possible)	
Temperature resistance	-20°C to +80°C	
Chemical resistance	resistant to simple oils and grease, petrol, ozone	
Processing	contours can be grinded and milled and surface grinded	



PU 385

Properties				
Colour	transparent			
Standard thickness [mm]	3	4	5	6
Min. pulley diameter [mm]	80	120	150	180
Material / Hardness	polyurethane/approx. 85 Shore A			
Tolerances	tolerance for total thickness (timing belt + coating) ± 0,4 mm (grinded ±0,1 mm possible)			
Temperature resistance	-20°C to +80°C			
Chemical resistance	resistant to simple oils and grease, petrol, ozone			
Processing	contours can be grinded and milled and surface grinded			



HV film

Properties		
Colour	transparent glossy	
Standard thickness [mm]	1	2
Min. pulley diameter [mm]	60	80
Material / Hardness	polyurethane/approx. 85 Shore A	
Tolerances	tolerance for total thickness (timing belt + coating) ± 0,4 mm (grinded ±0,1 mm possible)	
Temperature resistance	-20°C to +80°C	
Chemical resistance	resistant to simple oils and grease	
Processing	contours can be grinded and milled	

(glass, wood, metal, paper, textiles, cardboard packaging, wet area)



T-groove (TR1 and TR2)

Properties		
Colour	transparent	
Standard thickness [mm]	TR1: 2,4 Groove depth: 0,5	TR2: 2,5 Groove depth: 1,4
Min. pulley diameter [mm]	80	80
Material / Hardness	polyurethane/approx. 85 Shore A	
Tolerances	tolerance for total thickness (timing belt + coating) ± 0,5 mm	
Temperature resistance	-20°C to +80°C	
Chemical resistance	resistant to simple oils and grease, petrol, ozone	
Processing	-	



WM 385

Properties	
Colour	transparent
Standard thickness [mm]	4
Min. pulley diameter [mm]	120
Material / Hardness	polyurethane/approx. 85 Shore A
Tolerances	tolerance for total thickness (timing belt + coating) ± 0,4 mm
Temperature resistance	-20°C to +80°C
Chemical resistance	resistant to simple oils and grease, petrol, ozone
Processing	-



NP 385

Properties	
Colour	transparent
Standard thickness [mm]	4
Min. pulley diameter [mm]	120
Material / Hardness	polyurethane/approx. 85 Shore A
Tolerances	tolerance for total thickness (timing belt + coating) ±0,4 mm
Temperature resistance	-20°C to +80°C
Chemical resistance	resistant to simple oils and grease, petrol, ozone
Processing	-

Coatings for general transport tasks

(glass, wood, metal, paper, textiles, cardboard packaging, wet area)



FG 385

Properties	
Colour	transparent
Standard thickness [mm]	4
Min. pulley diameter [mm]	120
Material / Hardness	polyurethane/approx. 85 Shore A
Tolerances	tolerance for total thickness (timing belt + coating) $\pm 0,4$ mm
Temperature resistance	-20°C to +80°C
Chemical resistance	resistant to simple oils and grease, petrol, ozone
Processing	-
Note	the symmetrical position of the coating profile on the belt is not ensured. If this is required, please specify when ordering



PU 60

Properties	
Colour	transparent
Standard thickness [mm]	2 3 4 5 6
Min. pulley diameter [mm]	80 80 120 150 180
Material / Hardness	polyurethane/approx. 60 Shore A
Tolerances	tolerance for total thickness (timing belt + coating) $\pm 0,4$ mm (grinded $\pm 0,1$ mm possible)
Temperature resistance	-20°C to +80°C
Chemical resistance	resistant to simple oils and grease, petrol, ozone
Processing	contours can be grinded and milled and surface grinded
Special feature	high wear resistance



Polythane D15

Properties	
Colour	yellowish-transparent, other colours upon request
Standard thickness [mm]	2 3 4 5 6
Min. pulley diameter [mm]	60 80 80 100 100
Material / Hardness	polyurethane/approx. 70 Shore A
Tolerances	tolerance for total thickness (timing belt + coating) $\pm 0,6$ mm (grinded $\pm 0,1$ mm possible)
Temperature resistance	-20°C to +80°C
Chemical resistance	resistant to simple oils and greases, good resistance to ozone, UV radiation
Processing	contours can be grinded and milled and surface grinded

Coatings for general transport tasks

(glass, wood, metal, paper, textiles, cardboard packaging, wet area)

Properties	
Colour	yellow
Standard thickness [mm]	2 3 4 5 6 8 10
Min. pulley diameter [mm]	70 70 90 110 110 110 130
Material / Hardness	polyurethane/approx. 55 Shore A
Tolerances	tolerance for total thickness (timing belt + coating) $\pm 0,4$ mm (grinded $\pm 0,1$ mm possible)
Temperature resistance	-10°C to +70°C
Chemical resistance	resistant to simple oils and grease, petrol, ozone
Processing	contours can be grinded and milled and surface grinded
Other areas of use	solar industry



PU yellow

Properties	
Colour	grey
Standard thickness [mm]	2 3 4 5 6 8 10
Min. pulley diameter [mm]	70 70 90 110 110 110 130
Material / Hardness	polyurethane/approx. 55 Shore A
Tolerances	tolerance for total thickness (timing belt + coating) $\pm 0,4$ mm (grinded $\pm 0,1$ mm possible)
Temperature resistance	-10°C to +70°C
Chemical resistance	resistant to simple oils and grease, not water-resistant
Processing	contours can be grinded and milled and surface grinded



PU grey

Properties	
Colour	yellowish-brown
Standard thickness [mm]	2 3 4 5 6 8 10
Min. pulley diameter [mm]	40 60 60 80 80 100 120
Material / Hardness	microcellular elastomer polyurethane / approx. 350 kg/m ³
Tolerances	tolerance for total thickness (timing belt + coating) $\pm 0,7$ mm
Temperature resistance	-30°C to +80°C
Chemical resistance	resistant to simple oils and grease, ozone
Processing	contours can be grinded and milled and surface grinded



Celloflex

Coatings for general transport tasks

(glass, wood, metal, paper, textiles, cardboard packaging, wet area)

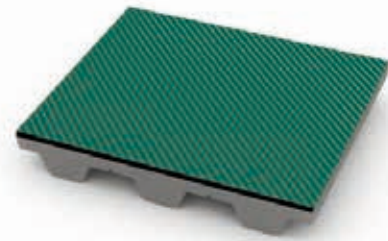

Hamid

Properties	
Colour	top layer green, bottom layer black
Standard thickness [mm]	1,4
Min. pulley diameter [mm]	20
Material / Hardness	transport side NBR rubber green, middle layer Hamid, bottom layer NBR rubber black
Tolerances	tolerance for total thickness (timing belt + coating) $\pm 0,5$ mm
Temperature resistance	-30°C to +60°C
Chemical resistance	resistant to simple oils and grease, water
Processing	-

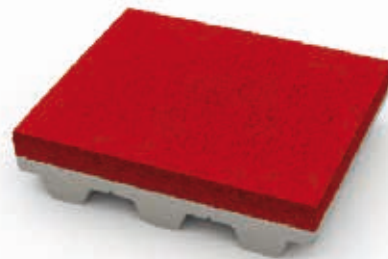

Linatex HM

Properties	
Colour	red
Standard thickness [mm]	2 3 4 5 6 8 10
Min. pulley diameter [mm]	60 80 80 80 100 100 120
Material / Hardness	95% natural rubber / approx. 38 Shore A
Tolerances	tolerance for total thickness (timing belt + coating) $-1/+1,8$ mm (grinded $\pm 0,2$ mm possible)
Temperature resistance	-40°C to +70°C
Chemical resistance	oil-proof to a limited extent, resistant to wet abrasion, water resistant, avoid exposure to direct sunlight
Processing	contours can be grinded and milled to some extent
Note	from 3 mm coating thickness please ask for advice

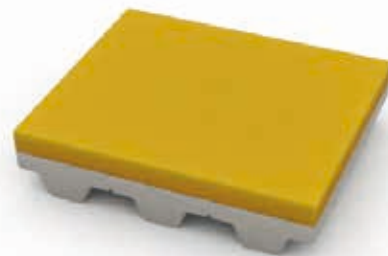

RP 430

Properties	
Colour	yellow
Standard thickness [mm]	2 3 4 5 6
Min. pulley diameter [mm]	40 50 50 70 70
Material / Hardness	natural rubber, approx. 39 Shore A
Tolerances	tolerance for total thickness (timing belt + coating) $\pm 0,7$ mm (grinded $\pm 0,2$ mm possible)
Temperature resistance	-35°C to +80°C
Chemical resistance	resistant to simple oils and grease
Processing	contours can be grinded and milled to some extent and surface grinded

Coatings for general transport tasks

(glass, wood, metal, paper, textiles, cardboard packaging, wet area)



Correx

Properties	
Colour	light brown
Standard thickness [mm]	6 10
Min. pulley diameter [mm]	80 120
Material / Hardness	para rubber, approx. 36 Shore A
Tolerances	tolerance for total thickness (timing belt + coating) $\pm 0,7$ mm (grinded $\pm 0,2$ mm possible)
Temperature resistance	up to approx. +70°C
Chemical resistance	resistant to simple oils and grease
Processing	contours can be grinded and milled to some extent and surface grinded

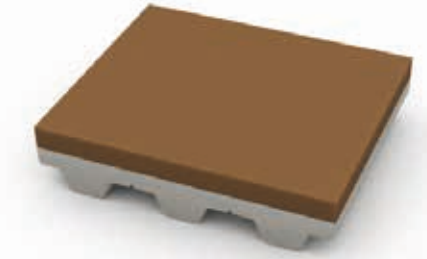

Sylomer brown

Properties	
Colour	light brown
Standard thickness [mm]	6 12 (Other thicknesses upon request)
Min. pulley diameter [mm]	60 80
Material / Hardness	mixed cell polyurethane, 400 kg/m ³
Tolerances	tolerance for total thickness (timing belt + coating) $\pm 0,7$ mm (grinded $\pm 0,3$ mm possible)
Temperature resistance	-30°C to +70°C
Chemical resistance	resistant to simple oils and grease
Processing	contours can be grinded and milled to some extent and surface grinded

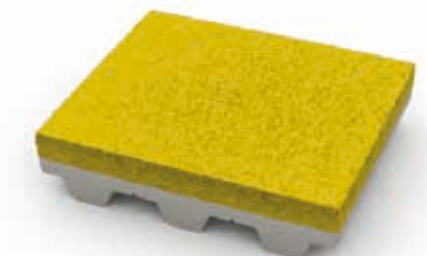

Sylomer yellow

Properties	
Colour	yellow
Standard thickness [mm]	6 12 (Other thicknesses upon request)
Min. pulley diameter [mm]	60 80
Material / Hardness	mixed cell polyurethane, 150 kg/m ³
Tolerances	tolerance for total thickness (timing belt + coating) $\pm 0,7$ mm (grinded $\pm 0,3$ mm possible)
Temperature resistance	-30°C to +70°C
Chemical resistance	resistant to simple oils and grease
Processing	contours can be grinded and milled to some extent and surface grinded

(glass, wood, metal, paper, textiles, cardboard packaging, wet area)



Sylomer blue

Properties			
Colour	blue		
Standard thickness [mm]	6	12	(Other thicknesses upon request)
Min. pulley diameter [mm]	60	80	
Material / Hardness	mixed cell polyurethane, 220 kg/m ³		
Tolerances	tolerance for total thickness (timing belt + coating) ±0,7 mm (grinded ±0,3 mm possible)		
Temperature resistance	-30°C to +70°C		
Chemical resistance	resistant to simple oils and grease		
Processing	contours can be grinded and milled to some extent and surface grinded		



Sylomer green

Properties			
Colour	green		
Standard thickness [mm]	6	12	(Other thicknesses upon request)
Min. pulley diameter [mm]	60	80	
Material / Hardness	mixed cell polyurethane, 300 kg/m ³		
Tolerances	tolerance for total thickness (timing belt + coating) ±0,7 mm (grinded ±0,3 mm possible)		
Temperature resistance	-30°C to +70°C		
Chemical resistance	resistant to simple oils and grease		
Processing	contours can be grinded and milled to some extent and surface grinded		



Sylomer red

Properties			
Colour	red		
Standard thickness [mm]	6	12	(Other thicknesses upon request)
Min. pulley diameter [mm]	80	100	
Material / Hardness	mixed cell polyurethane, 510 kg/m ³		
Tolerances	tolerance for total thickness (timing belt + coating) ±0,7 mm (grinded ±0,3 mm possible)		
Temperature resistance	-30°C to +70°C		
Chemical resistance	resistant to simple oils and grease		
Processing	contours can be grinded and milled to some extent and surface grinded		

(glass, wood, metal, paper, textiles, cardboard packaging, wet area)



Sylomer grey

Properties			
Colour	grey		
Standard thickness [mm]	6	12	(Other thicknesses upon request)
Min. pulley diameter [mm]	80	100	
Material / Hardness	mixed cell polyurethane, 680 kg/m ³		
Tolerances	tolerance for total thickness (timing belt + coating) ±0,7 mm (grinded ±0,3 mm possible)		
Temperature resistance	-30°C to +70°C		
Chemical resistance	resistant to simple oils and grease		
Processing	contours can be grinded and milled to some extent and surface grinded		

Properties	
Colour	green
Standard thickness [mm]	6
Min. pulley diameter [mm]	100
Material / Hardness	closed-cell polyurethane, 600 kg/m ³
Tolerances	tolerance for total thickness (timing belt + coating) ±0,7 mm (grinded ±0,3 mm possible)
Temperature resistance	-30°C to +70°C
Chemical resistance	resistant to simple oils and grease
Processing	contours can be grinded and milled to some extent and surface grinded



Sylodyn green

Properties	
Colour	yellow
Standard thickness [mm]	6
Min. pulley diameter [mm]	80
Material / Hardness	closed-cell polyurethane, 450 kg/m ³
Tolerances	tolerance for total thickness (timing belt + coating) ±0,7 mm (grinded ±0,3 mm possible)
Temperature resistance	-30°C to +70°C
Chemical resistance	resistant to simple oils and grease
Processing	contours can be grinded and milled to some extent and surface grinded



Sylodyn yellow

(glass, wood, metal, paper, textiles, cardboard packaging, wet area)



Supergrip green

Properties	
Colour	green
Standard thickness [mm]	4
Min. pulley diameter [mm]	60
Material / Hardness	PVC, approx. 40 Shore A
Tolerances	tolerance for total thickness (timing belt + coating) ±0,5 mm
Temperature resistance	-15°C to +90°C
Chemical resistance	limited resistance to solvents, oils and greases; resistant to acids and alkalis
Processing	-



Supergrip blue

Properties	
Colour	bluish-green
Standard thickness [mm]	4
Min. pulley diameter [mm]	60
Material / Hardness	PVC, approx. 40 Shore A
Tolerances	tolerance for total thickness (timing belt + coating) ±0,5 mm
Temperature resistance	-15°C to +90°C
Chemical resistance	limited resistance to solvents, oils and greases; resistant to acids and alkalis
Processing	-



Minigrip green

Properties	
Colour	green
Standard thickness [mm]	1,5
Min. pulley diameter [mm]	30
Material / Hardness	PVC, approx. 65 Shore A
Tolerances	tolerance for total thickness (timing belt + coating) ±0,5 mm
Temperature resistance	-10°C to +110°C
Chemical resistance	resistant to oils, greases, acids and alkalis
Processing	-

(glass, wood, metal, paper, textiles, cardboard packaging, wet area)



Minigrip blue

Properties	
Colour	bluish-green
Standard thickness [mm]	1,5
Min. pulley diameter [mm]	30
Material / Hardness	PVC, approx. 50 Shore A
Tolerances	tolerance for total thickness (timing belt + coating) ±0,5 mm
Temperature resistance	-15°C to +90°C
Chemical resistance	resistant to solvents, oils and greases; resistant to acids and alkalis
Processing	-



PVC film blue

Properties	
Colour	blue
Standard thickness [mm]	1 (2 / 3 / 4 / 5 / 6 mm upon request)
Min. pulley diameter [mm]	30
Material / Hardness	PVC, approx. 65 Shore A
Tolerances	tolerance for total thickness (timing belt + coating) ±0,5 mm
Temperature resistance	-15°C to +90°C
Chemical resistance	limited resistance to solvents, oils and greases; resistant to acids and alkalis
Processing	-
Other areas of use	pharmaceutical industry



Porol

Properties	
Colour	black
Standard thickness [mm]	3 5 10
Min. pulley diameter [mm]	40 60 80
Material / Hardness	closed-cell cellular rubber, 160-200 kg/m³
Tolerances	tolerance for total thickness (timing belt + coating) ±0,7 mm
Temperature resistance	-40°C to +75°C
Chemical resistance	resistant to water, seawater, methanol, acetone, detergent, acids and alkalis
Processing	-

Coatings for general transport tasks

(glass, wood, metal, paper, textiles, cardboard packaging, wet area)

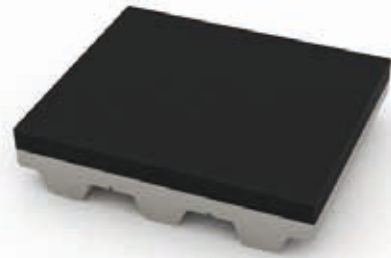

NBR 65

Properties		
Colour	black	
Standard thickness [mm]	1,5	3
Min. pulley diameter [mm]	60	80
Material / Hardness	nitrile rubber, approx. 60-70 Shore A	
Tolerances	tolerance for total thickness (timing belt + coating) $\pm 0,6$ mm (grinded $\pm 0,2$ mm possible)	
Temperature resistance	-35°C to +70°C	
Chemical resistance	resistant to oils, and to some extent acids and alkalis	
Processing	contours can be grinded and milled to some extent and surface grinded	

Coatings for transporting food



Linaplus FG FDA

Properties			
Colour	white		
Standard thickness [mm]	3	5	6
Min. pulley diameter [mm]	40	40	40
Material / Hardness	vulcanised natural rubber, approx. 38 Shore A		
Tolerances	tolerance for total thickness (timing belt + coating) -1/+1,8 mm (grinded $\pm 0,2$ mm possible)		
Temperature resistance	-40°C to +70°C		
Chemical resistance	resistant to chemicals; material does not leave pressure marks		
Processing	contours can be grinded and milled and surface grinded		
Note	FDA approval in conformity with the criteria of the FDA Code of Federal Regulations, section 177.1680, the European Regulation (EC) 1935-2004, Regulation (EU) no. 10/2011 and European Commission Directives 90/128/EEC and 96/11/EC		



PVC herringbone FDA

Properties	
Colour	white
Standard thickness [mm]	3
Min. pulley diameter [mm]	60
Material / Hardness	PVC, approx. 65 Shore A
Tolerances	tolerance for total thickness (timing belt + coating) $\pm 0,5$ mm
Temperature resistance	-10°C to +110°C
Chemical resistance	resistant to oils, greases, acids and alkalis
Processing	-
Note	FDA approval in conformity with the criteria of the FDA Code of Federal Regulations, section 177.1680, the European Regulation (EC) 1935-2004, Regulation (EU) no. 10/2011 and European Commission Directives 90/128/EEC and 96/11/EC



HV film FDA

Properties		
Colour	transparent glossy	
Standard thickness [mm]	1	2
Min. pulley diameter [mm]	60	80
Material / Hardness	polyurethane/approx. 85 Shore A	
Tolerances	tolerance for total thickness (timing belt + coating) $\pm 0,4$ mm (grinded $\pm 0,1$ mm possible)	
Temperature resistance	-20°C to +80°C	
Chemical resistance	resistant to simple oils and grease	
Processing	contours can be grinded and milled	

Coatings for transporting food



PVC film white FDA

Properties	
Colour	white
Standard thickness [mm]	2 (1 / 3 / 4 / 5 / 6 mm upon request)
Min. pulley diameter [mm]	60
Material / Hardness	PVC, approx. 48 Shore A
Tolerances	tolerance for total thickness (timing belt + coating) ±0,5 mm
Temperature resistance	-10°C to +110°C
Chemical resistance	resistant to oils, greases, acids and alkalis
Processing	-
Note	FDA approval in conformity with the criteria of the FDA Code of Federal Regulations, section 177.1680, the European Regulations (EC) 1935-2004, (EC) 2023/2006 and (EU) no. 10/2011 and European Commission Directives 90/128/EEC and 96/11/EC



PVC dots white FDA

Properties	
Colour	white
Standard thickness [mm]	1,5
Min. pulley diameter [mm]	60
Material / Hardness	PVC, approx. 60 Shore A
Tolerances	tolerance for total thickness (timing belt + coating) ±0,5 mm
Temperature resistance	-10°C to +110°C
Chemical resistance	resistant to oils, greases, acids and alkalis
Processing	-
Note	FDA approval in conformity with the criteria of the FDA Code of Federal Regulations, section 177.1680, the European Regulations (EC) 1935-2004, (EC) 2023/2006 and (EU) no. 10/2011 and European Commission Directives 90/128/EEC and 96/11/EC



Supergrip FDA

Properties	
Colour	white
Standard thickness [mm]	4
Min. pulley diameter [mm]	60
Material / Hardness	PVC, approx. 55 Shore A
Tolerances	tolerance for total thickness (timing belt + coating) ±0,5 mm
Temperature resistance	-10°C to +110°C
Chemical resistance	resistant to oils, greases, acids and alkalis
Processing	-
Note	FDA approval in conformity with the criteria of the FDA Code of Federal Regulations, section 177.1680, the European Regulations (EC) 1935-2004, (EC) 2023/2006 and (EU) no. 10/2011 and European Commission Directives 90/128/EEC and 96/11/EC

Coatings with friction-reducing properties

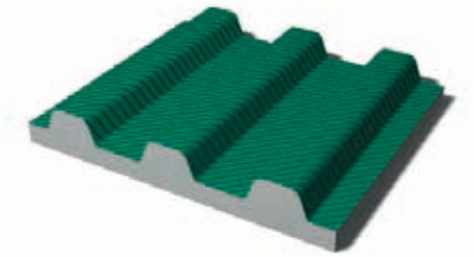

PAZ

Properties	
Colour	green
Standard thickness [mm]	0,5 0,8
Min. pulley diameter [mm]	15 25
Material / Hardness	polyamid
Tolerances	± 0,2 mm
Temperature resistance	-20°C to +50°C
Chemical resistance	resistant to simple oils and grease
Processing	-

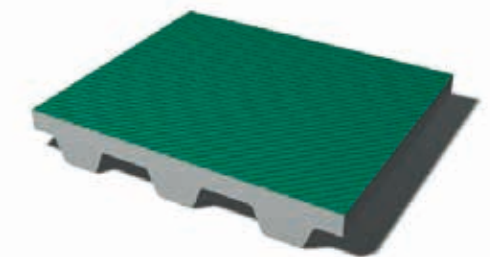

PAR

Properties	
Colour	green
Standard thickness [mm]	0,5 0,8
Min. pulley diameter [mm]	15 25
Material / Hardness	polyamid
Tolerances	± 0,2 mm
Temperature resistance	-20°C to +50°C
Chemical resistance	resistant to simple oils and grease
Processing	-

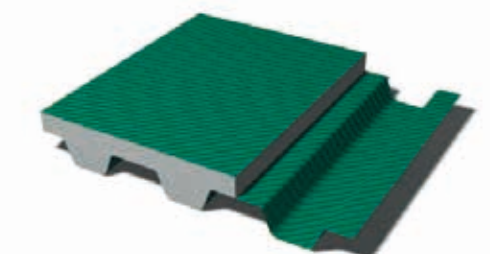

PAZ-PAR

Properties	
Colour	green
Standard thickness [mm]	0,5 0,8
Min. pulley diameter [mm]	15 25
Material / Hardness	polyamid
Tolerances	±0,2 mm
Temperature resistance	-20°C to +50°C
Chemical resistance	resistant to simple oils and grease
Processing	-

Coatings for use at higher contact temperatures



Linatril

Properties			
Colour	orange		
Standard thickness [mm]	3	5	6
Min. pulley diameter [mm]	60	60	60
Material / Hardness	Nitrile-based vulcanised material, approx. 55 Shore A		
Tolerances	tolerance for total thickness (timing belt + coating) -1/+1,8 mm (grinded $\pm 0,2$ mm possible)		
Temperature resistance	-20°C to +110°C		
Chemical resistance	resistant to oils, greases and other chemicals; water resistant		
Processing	contours can be grinded and milled and surface grinded		

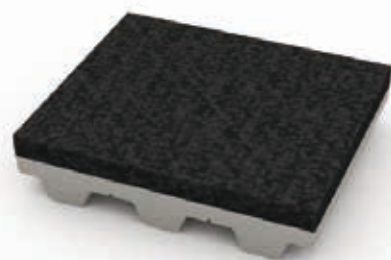

TT 60

Properties	
Colour	black
Standard thickness [mm]	2
Min. pulley diameter [mm]	120
Material / Hardness	polyester fleece
Tolerances	tolerance for total thickness (timing belt + coating) $\pm 0,5$ mm
Temperature resistance	-10°C to +120°C
Chemical resistance	against simple oils and greases; electrostatic properties
Processing	-
Areas of use	glass industry, as a conveyor belt in the warm area

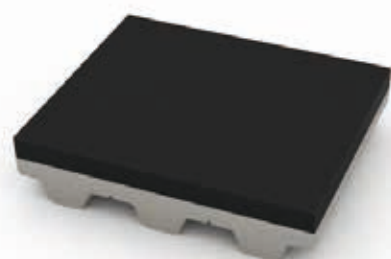

Viton

Properties		
Colour	black	
Standard thickness [mm]	2	4
Min. pulley diameter [mm]	80	100
Material / Hardness	synthetic fluoroelastomer, approx. 70-80 Shore A	
Tolerances	tolerance for total thickness (timing belt + coating) $\pm 0,6$ mm (grinded $\pm 0,2$ mm possible)	
Temperature resistance	-10°C to +190°C (up to 275°C for short periods)	
Chemical resistance	very good resistance to oils, greases, hydrocarbons, acids; impermeable to gas and water vapour	
Processing	contours can be grinded and milled to some extent and surface grinded.	
Potential applications	transportation of sensitive parts, cardboard packaging, transportation of glass and metal parts	

Coatings for use at higher contact temperatures

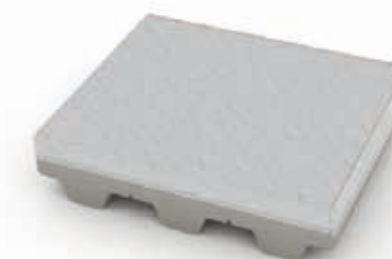

Chrome leather

Properties		
Colour	grey	
Standard thickness [mm]	2	3
Min. pulley diameter [mm]	100	120
Material / Hardness	leather tanned with chromium salts	
Tolerances	tolerance for total thickness (timing belt + coating) $\pm 0,7$ mm	
Temperature resistance	-10°C to +120°C	
Chemical resistance	resistant to oils and greases; weather resistant	
Potential applications	transportation of oil and grease soaked parts, transportation of sheet metal and pipes	

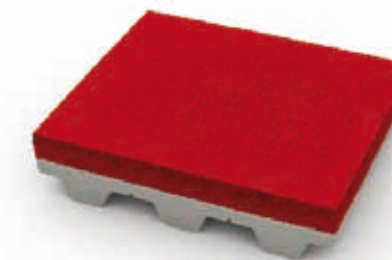

Linard 60

Properties			
Colour	red		
Standard thickness [mm]	3	5	6
Min. pulley diameter [mm]	60	60	60
Material / Hardness	silica-reinforced natural rubber, approx. 60 Shore A		
Tolerances	tolerance for total thickness (timing belt + coating) -1/+1,8 mm (grinded $\pm 0,2$ mm possible)		
Temperature resistance	-20°C to +110°C		
Chemical resistance	resistant to simple oils and greases; very high rebound elasticity		
Processing	contours can be grinded and milled and surface grinded		

Coatings with electrically conductive properties

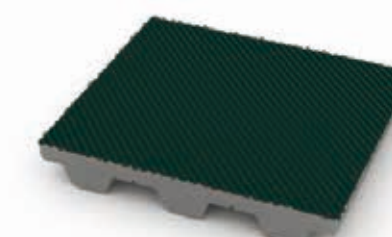

PA fabric, antistatic

Properties	
Colour	black
Standard thickness [mm]	0,6
Min. pulley diameter [mm]	20
Material / Hardness	approx. 0,5 mm PU 385, top layer 0,1 mm antistatic fabric
Tolerances	tolerance for total thickness (timing belt + coating) $\pm 0,4$ mm
Conductance	10^5 ohm when new
Potential applications	accumulation conveyors for electrical components

Mechanical processing

Coated BRECO® and BRECOFLEX® timing belts can be mechanically processed for special functional characteristics, depending on the properties of the coating.

Transport belts with thick coatings are less flexible. Their use therefore requires a larger diameter of toothed pulley. Transverse slits or grooves can increase the flexibility of the coating. Where technically possible from a production perspective, milled grooves are used for secure handling and better positioning of products.

Perforated BRECO® timing belts are used in vacuum transport systems. BRECOFLEX® timing belts are also available for this purpose. The preferred version of BRECO® timing belts is manufactured with tension carrier-free zones. The teeth are milled lengthways according to the hole size.

In mechanical processing, the larger dimensional tolerances that occur due to material elasticities should be noted. Increased tension can occur in the fibres on the edge of the coatings as a result of mechanical processing when revolving around the toothed pulleys, which may require the use of larger toothed pulley diameters. Please consult our technical advice service for this.

Milling, drilling, stamping, grinding



Milling, drilling, stamping, grinding

BRECO® and BRECOFLEX® timing belts can be mechanically processed for special functional characteristics. Timing belts with thick backs that offer a broad range of possibilities for design engineers are available especially for mechanical processing.

Please note that timing belts with thicker backs are less flexible and require toothed pulleys with larger diameters. Better flexibility is achieved through transverse grooves or slits.



Back cross milling

Cross grooves on the belt back enhance the flexibility of the belt. Milled grooves are, in as much as they are possible from the technical feasibility point of view, used to improve safe loading and secure positioning of the products on the belts.

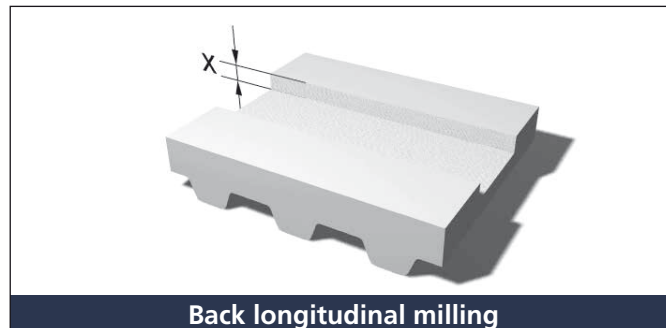

Back longitudinal milling

Independent on the belt pitch, the belt back shaping offers a wide range of design variants for customised solutions. In this manner, belt guiding can be achieved by a trapezoidal back profile, or a round section supported and moved by means of a prism shaped cross section. Dimensions are to be indicated as depth measure x in relation to the belt back.



Back grinding

The backs of all BRECOFLEX® timing belts are ground as standard. For reasons of precision or in order to obtain a roughened surface, all other timing belts of the BRECO delivery range can be ground.

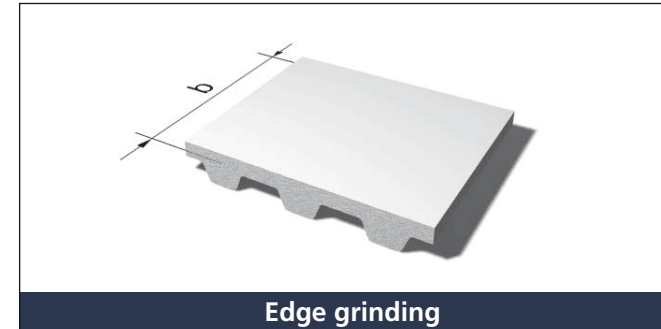

Grinding belt edges

Narrower tolerances in the belt width can be achieved by grinding the belt edges. The edges may need to be grinded especially for BRECO® timing belts guided by rails. The narrower standard tolerance is ± 0.3 mm. Further narrowing is possible. Please ask for technical advice in this regard.

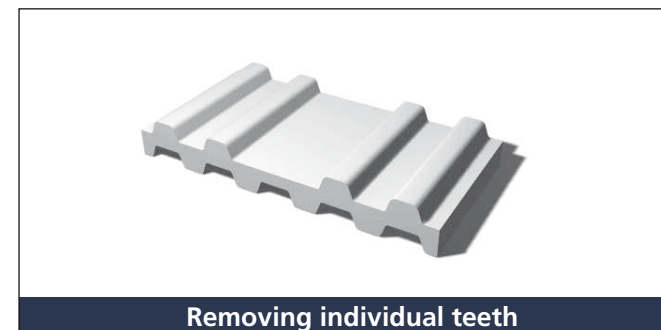

Removing individual teeth

The removal of individual teeth or entire groups of teeth is possible and should be done for accurate interlinking purposes, for example if the remaining teeth are used to accept the transported goods in a specific position.

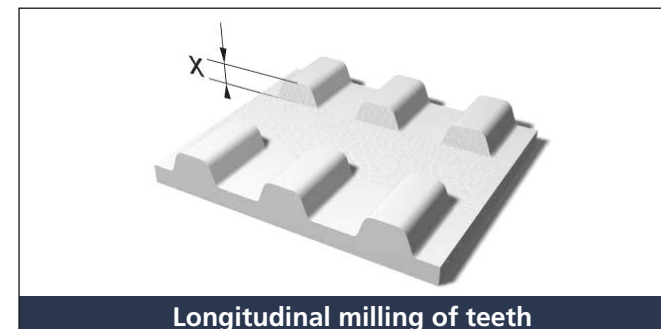

Milling teeth lengthwise

BRECO® timing belts with tooth profiles milled lengthwise are often used in combination with tension carrier-free zones in vacuum transport systems. BRECO® timing belts offer a wide range of products for use in this area. The processing depth x is measured starting from the tip of the tooth and generally ending at the bottom of the space.

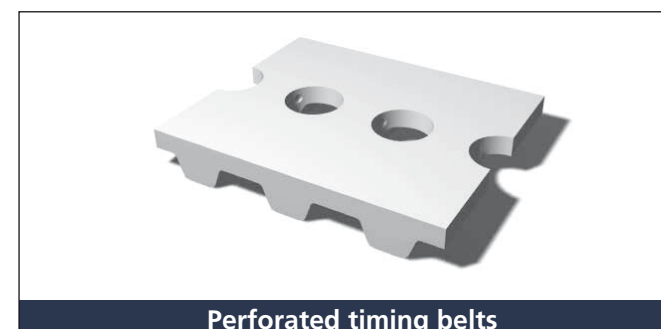

Perforated timing belts

The use of perforated BRECO® and BRECOFLEX® timing belts is preferred for areas without tension members (to a limited degree also available as BRECOFLEX® timing belts) and areas with teeth removed in the longitudinal direction, if they are to be employed as suction belts in the vacuum transport technology. The multitude of design possibilities of BRECO® timing belts as vacuum timing belts as well as our extensive experience especially in this field includes the transport of delicate films up to sheet bars of several square meters in size.

Water jet cutting

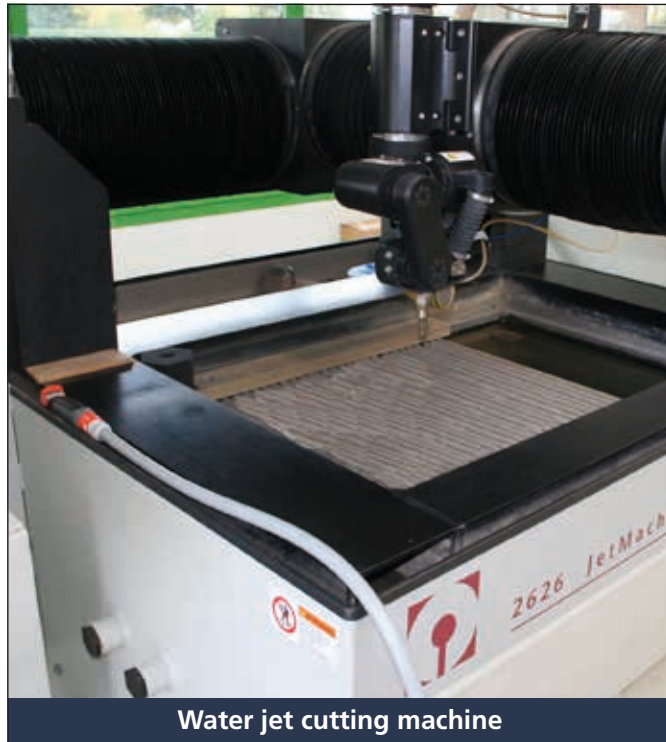

Water jet cutting machine

Water jet cutting

- Precise
- Fast
- Clean
- Variety of uses
- Environmentally friendly

In addition to milling, drilling, stamping and grinding, BRECO® and BRECOFLEX® timing belts can also be processed with a water jet cutting machine. Water jet cutting offers a wide range of possibilities. A variety of cut-out contours can be realised with high precision for special purposes. The process is also suitable for cutting flight shapes from pre-assembled polyurethane plates of different thicknesses.

Benefits

- Precise cutting edges
- High cutting accuracy
- Very low heat generation and no warping
- No burrs
- Hardly any post-processing required

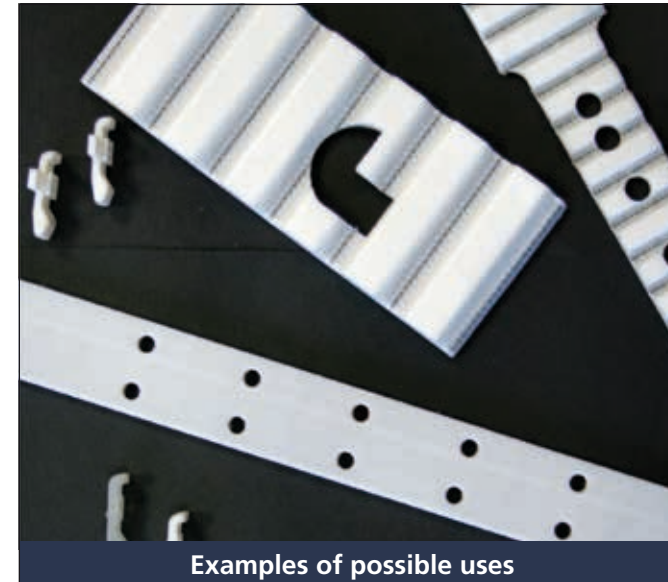

Examples of possible uses

Possible uses

- Cut-outs (round, oval, triangular, rectangular, etc.)
- Cut-outs with rounded parts and straight edges
- Special cuts for splicing
- Contour cutting of flight shapes



Cut-outs

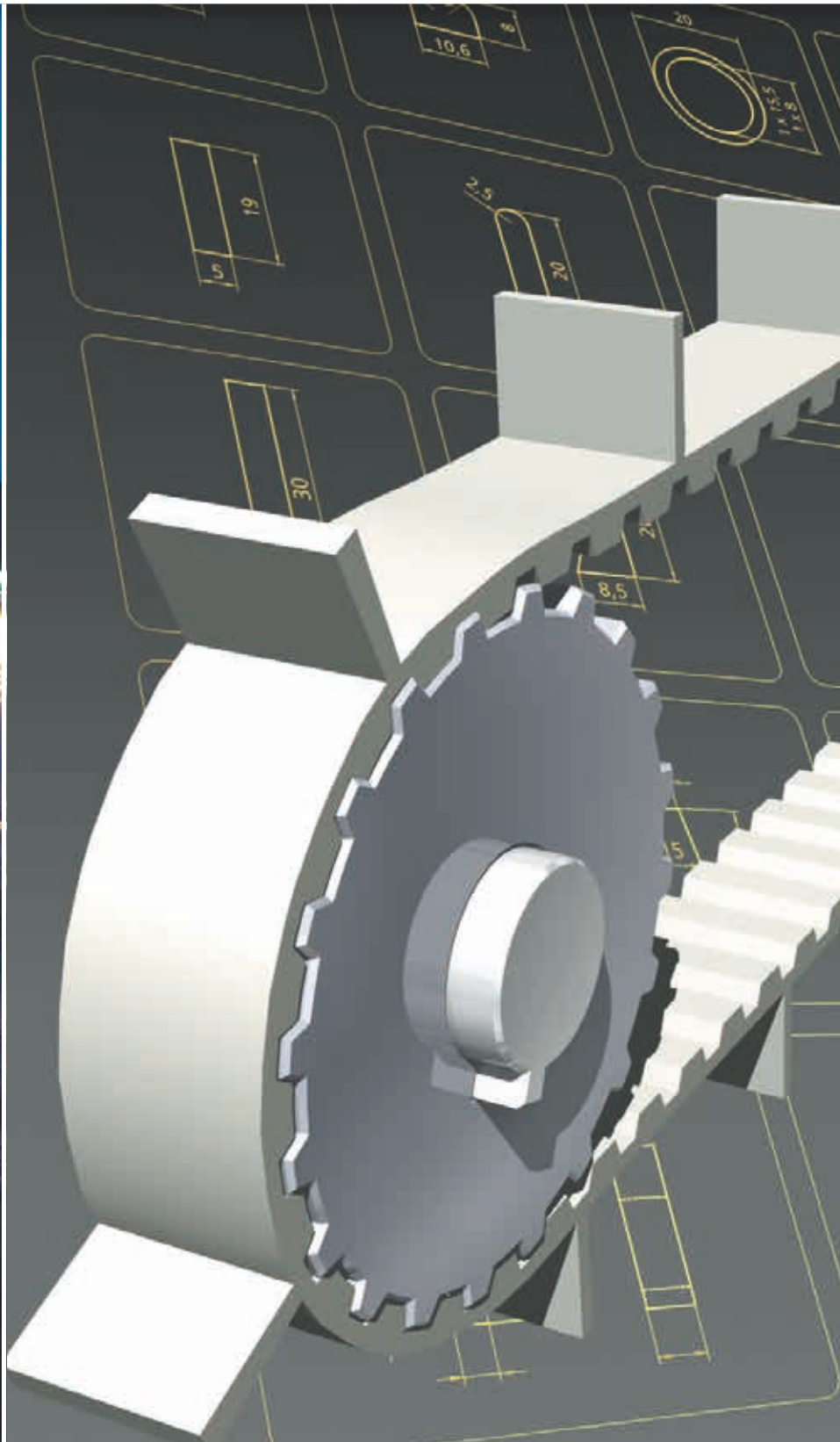

Variety of uses

Whichever transport purpose BRECO® and BRECOFLEX® timing belts are used for, the back of the belt can be fitted with any number and sequence of welded-on profiles.

The profiles consist of polyurethane, the same high-quality material as the timing belts themselves. A selection of profile shapes with standard dimensions is shown in this catalogue.

Other customer-specific profile shapes are also available. Within our production capabilities, the profile shape for transported goods and transportation purposes can be freely determined according to the customer's requirements. The injection moulds are manufactured in our own tool building facilities. This ensures fast availability.

Please observe the design guidelines on the following pages.



Rotary indexing magazine



Supply belt

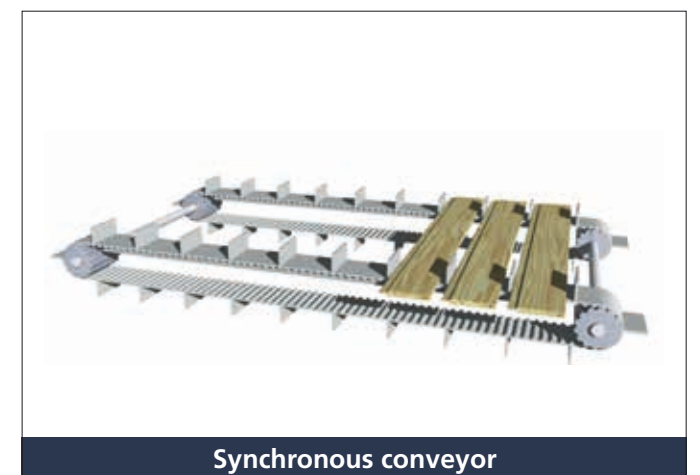

Synchronous conveyor

Construction features

At first, the basis for the selection of belt type, belt length and the depending pulleys is the surrounding construction. All belt types of our manufacturing range can be equipped with flights/profiles. Timing belts together with bed plates enable a reduced friction transportation. BRECO® and BRECOFLEX® timing belts in the version PAZ are alternatively available.

Profile selection

The material to be transported and the transport purpose influence the selection of the flight. Following possibilities of flight versions are available:

- Profiles of existing standard tools
Profiles are manufactured as polyurethane moulded part
Over 2500 standard profiles are available. Depending on their dimensions, standard profiles can be reworked by mechanical processes (drilling, milling). If necessary, explain design requirements by means of a drawing.
- Profiles of sheet material
Depending on the quantity, flights will possibly be cut from pre-fabricated PUR sheets. The following board thicknesses are available:
1,5; 2; 3; 4; 5; 6; 7; 8; 10; 11; 15; 20 mm
- Profiles of new tool
Within the framework of our production possibilities, there are practically no limitations for new design requirements as far as the shape of injection moulded flights are concerned. Costs for tools and moulds might apply.

Profile position opposite tooth

The belt flexibility of timing belts is located mainly in the tooth gap area. To retain the timing belt flexibility around the pulley, the profile position „opposite the tooth“ is to be preferred.

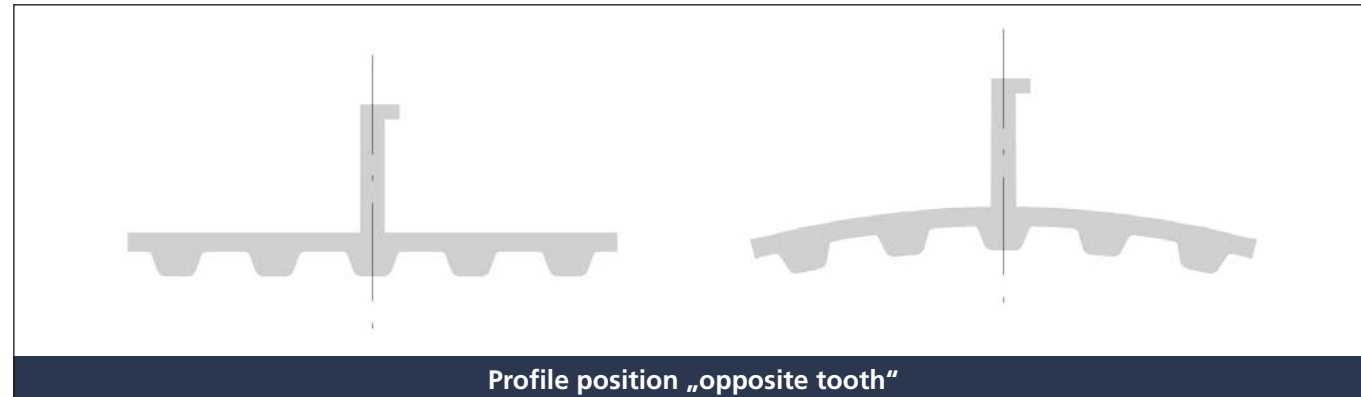

Profile pitch Tooth pitch

We recommend to select a Profile pitch which is an integral multiple of that of the tooth. Profile pitches other than the integral multiple of the tooth pitch can be supplied, it has, however, to be noted, that a uniform offset of the profile position in relation to the tooth position will accumulate.

Tolerances

The reached profile position of each individual profile is ± 0.5 mm of the intended set point position. A tolerance of ± 0.5 mm is to be taken into account for the profile height.

Ordering example:

Construction features

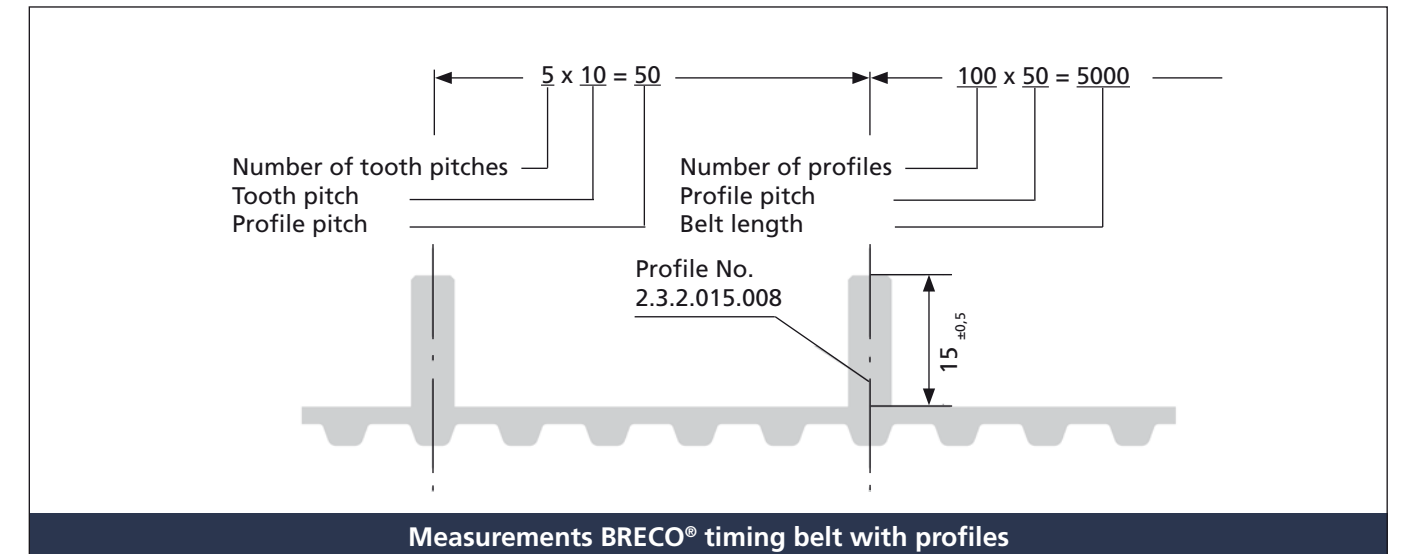

The equipping of the timing belt with profiles is always made as a multiple of the tooth pitch, i.e. the welded on flight position follows exactly the belt tooth pitch. For this reason, a cumulative error from profile pitch to tooth pitch will not occur.

For the required timing belt with profiles the order should preferably be accompanied by a dimensional drawing. The timing belt with profiles can also be defined and transmitted by the order text.

Example: BRECO® timing belt 50 T 10/5000 V-PAZ with welded-on profiles
Profile no. 2.3.2.015.008,
Number of profiles 100,
Profile pitch 50,
Profile position opposite the tooth.

Joined version

Joining is made by welding the full profile fitting surface on the back of the belt.

Flash

A flash builds up between flight and back of the belt. A polyurethane overhang with a 0.5 to 1 mm radius could form. **Should the flash impair the intended function, ask for „flash removed“ in your order information.**

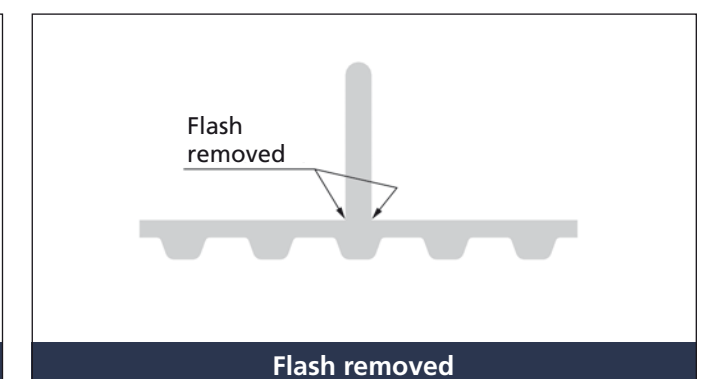
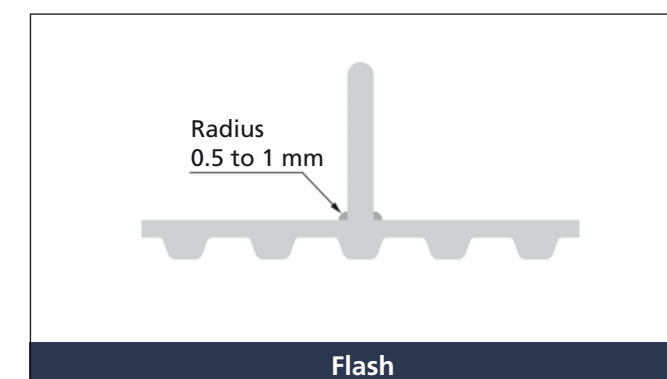

Construction features

Profile thickness s

The timing belt flexibility can be influenced by the welded-on flight. Note as a rule that the flight thickness s is to be selected as thin as possible. The table below shows the individually recommended maximum profile thickness s in mm in relation to the selected number of pulley teeth.

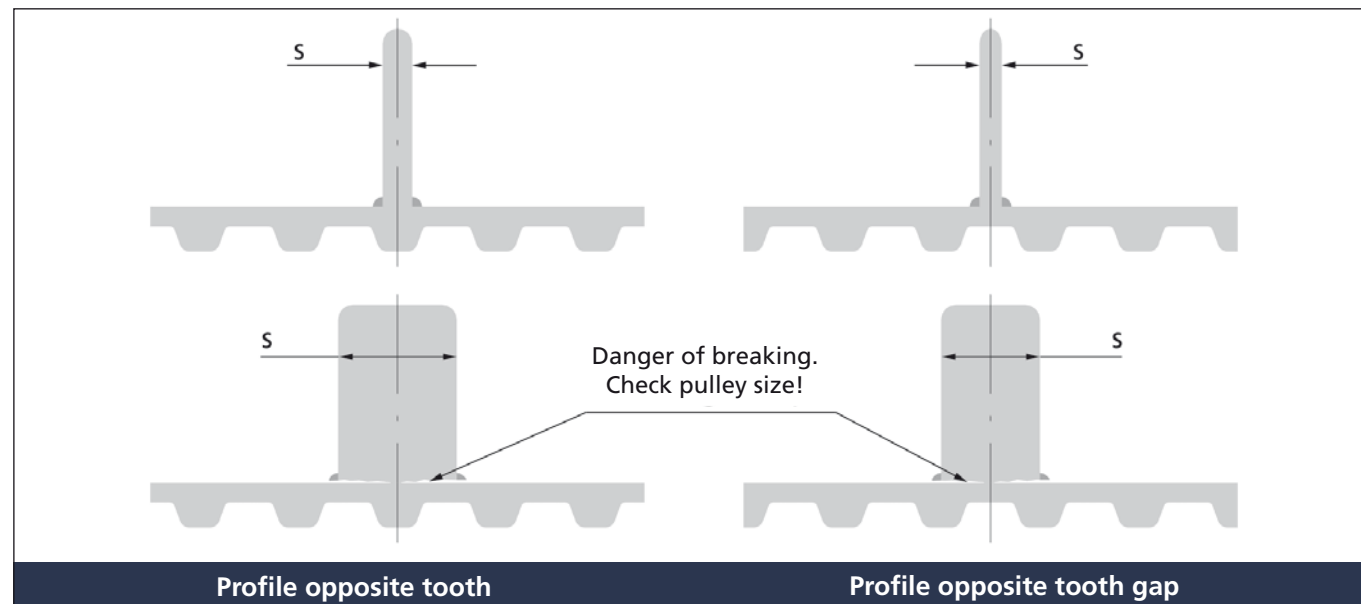

Max. thickness s [mm]

Type / pitch	Max. profile thickness in mm when welded on position is opposite tooth													
	Max. profile thickness in mm when welded on position is opposite tooth gap													
	Number of pulley teeth													
	20	25	30	40	50	60	100	20	25	30	40	50	60	100
T2,5	2,5	1,5	3	1,5	3	2	4	2	4,5	3	5	4	6	6
T5	5	2	6	2	6	3	8	4	9	6	10	8	12	10
T10	8	3	9	4	10	4	12	6	14	9	15	12	20	20
T20	12	5	13	5	15	6	18	8	20	12	23	20	30	30
AT3	3	1,5	4	1,5	4	2	5	3	6	4	6,5	5	8	7
AT5	5	2	6	2	6	3	8	4	9	6	10	8	12	10
AT10	8	3	9	4	10	4	12	6	14	9	15	12	20	20
AT20	12	5	13	5	15	6	18	8	20	12	23	20	30	30
MXL	2	1	2,5	1	2,5	1,5	3,5	1,5	4	2	4,5	3	5	5
XL	5	2	6	2	6	3	8	4	9	6	10	8	12	10
L	6	3	7	3	8	4	10	5	12	7	13	10	16	16
H	8	4	9	5	10	6	12	7	14	10	15	12	20	20
XH	13	5	14	5	15	6	18	8	20	12	23	20	30	30

Example for the calculation of the profile thickness s for a BRECO® timing belt with pitch T10, which is running around a pulley with 20 teeth:

- When the profile position is „opposite the tooth”, profile thickness $s \leq 8$ mm,
- When the profile position is „opposite the tooth gap”, profile thickness $s \leq 3$ mm.

Remark:

We recommend to select the next smaller size as profile thickness when there are intermediate sizes (e.g. 22 teeth).

Construction features

Profiles with undercut

The timing belt flexibility is assured, when there are planned corresponding undercuts.

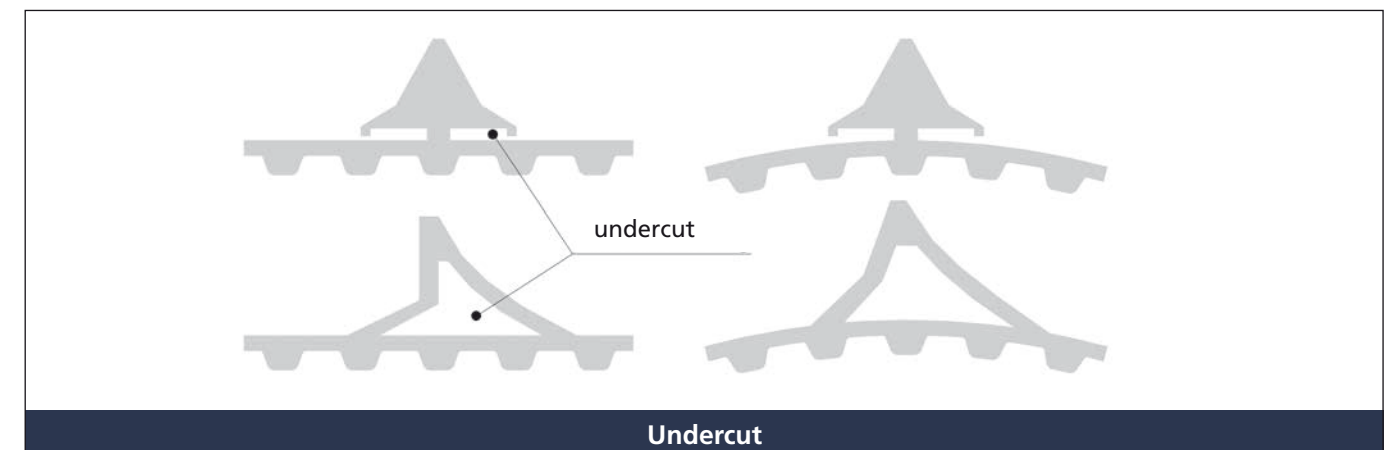

Profile pair

Profile pairs (profile chambers, profile pockets) are preferred in the transport technology for parts positioning and for so-called inset procedures. For the clearance between the profiles, the production tolerance amounts to ± 0.5 mm. Indicate a tolerance reduced to ± 0.2 mm separately, while taking make-ready and/or tool costs into consideration.

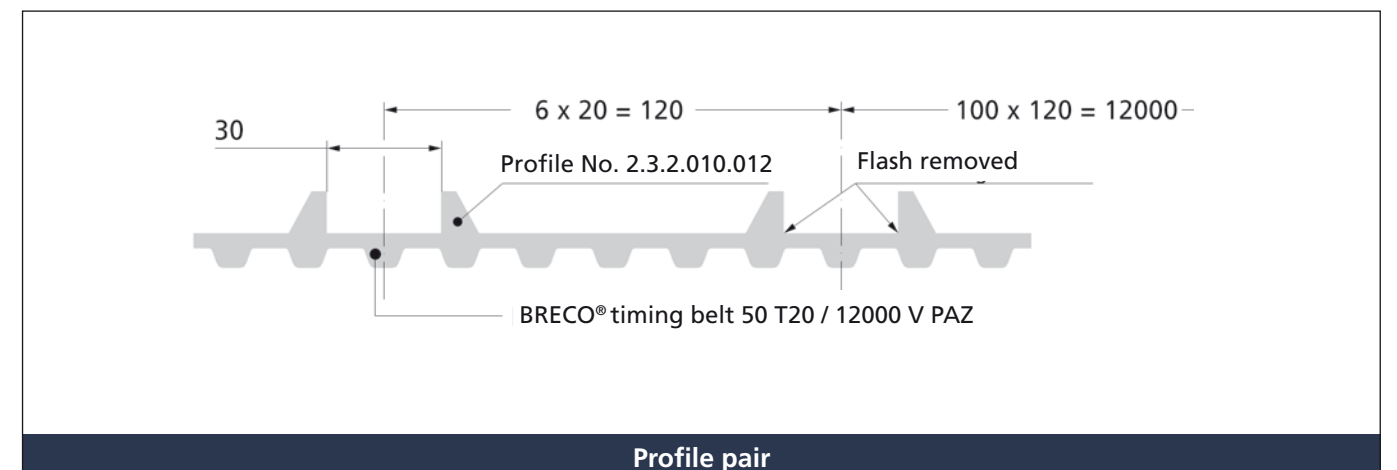

Construction features

Profiles with moulded inserts

Profiles with moulded inserts can be manufactured for special functional characteristics. To shape moulded inserts (steel, aluminium or similar) please ensure the existence of appropriate undercuts.
Remark: The orderer has to make available a sufficient number of moulded-in inserts with an approx. 5 % surplus for the manufacture of samples.

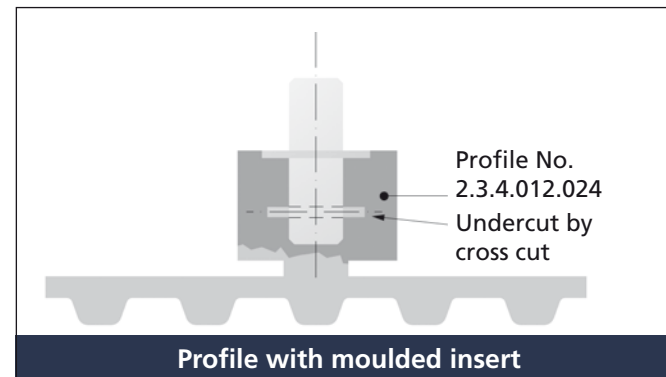

Profile with moulded insert

Profiles with bore holes

It is possible to ask for boreholes for special profile attachments. Tolerances are to be considered.

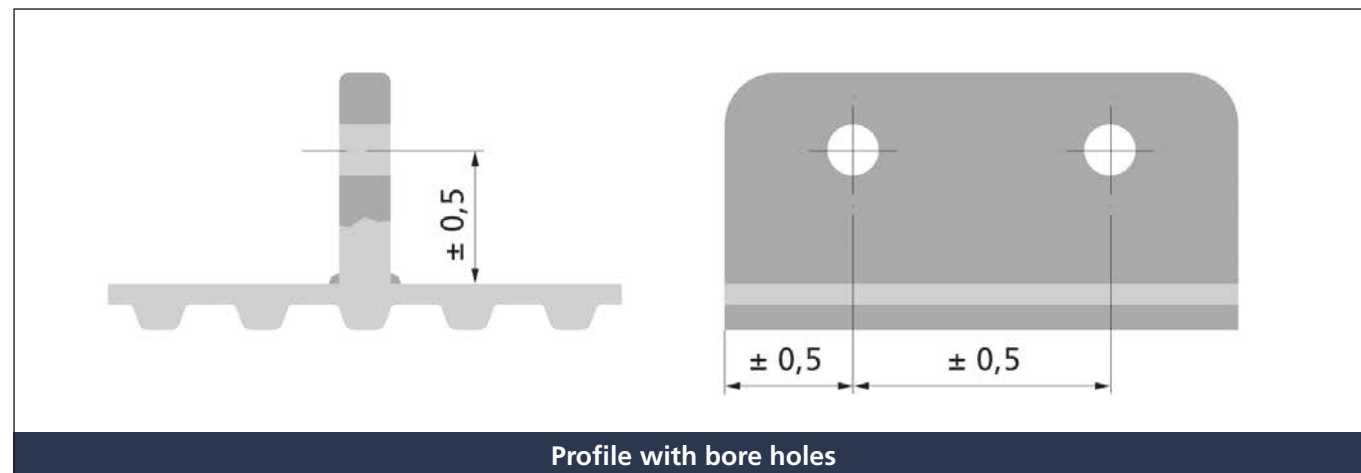

Profile with bore holes

Selection of standard profiles

These profiles for welding on only represent a small selection from our entire range. Over 2700 existing profile shapes are available. These profile shapes can be adapted to special requirements by mechanical processing in smaller series.

Our sales partners will gladly help you find solutions for certain transport tasks.

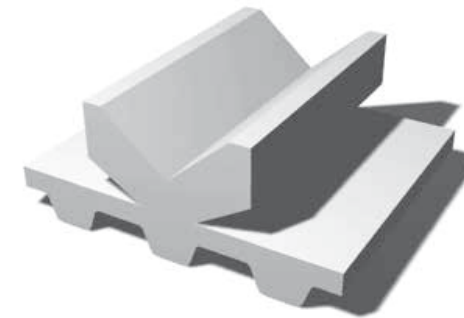

Profile no. 2.3.5.663

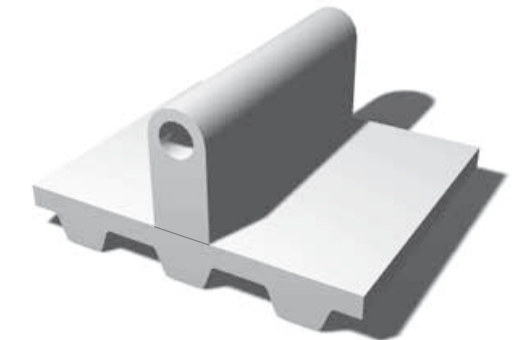

Profile no. 2.3.6.936

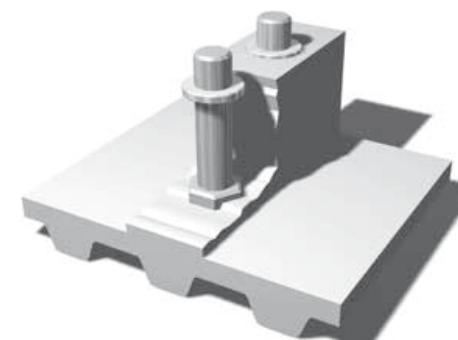

Profile no. 2.3.4.012.024

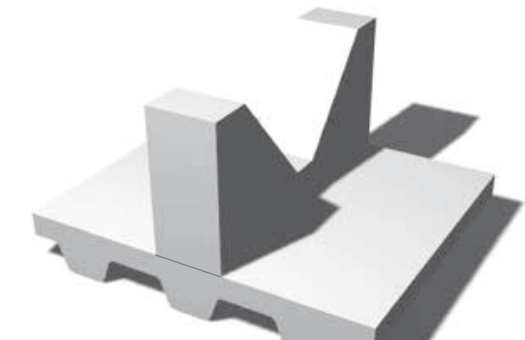

Profile no. 2.3.5.708

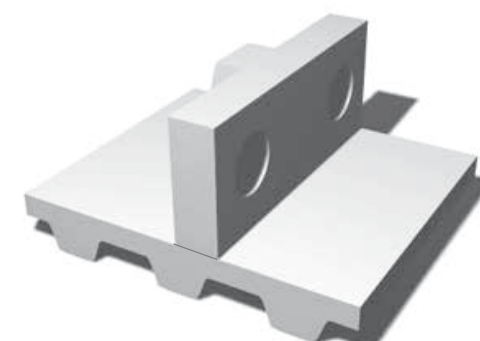

Profile no. 2.3.7.446

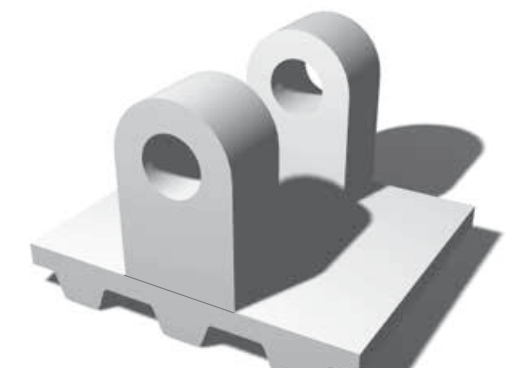

Profile no. 2.3.5.678

Selection of standard profiles

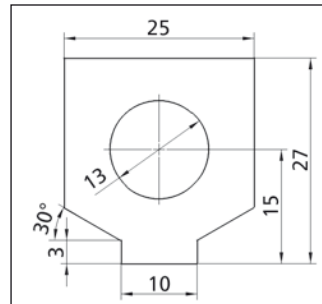

Depth: 50 mm
Profile No. 2.3.2.025.027

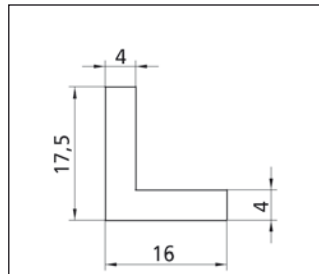

Depth: 48 mm
Profile No. 2.3.3.017.016

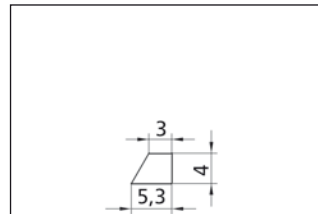

Depth: 25 mm
Profile No. 2.3.3.004.005

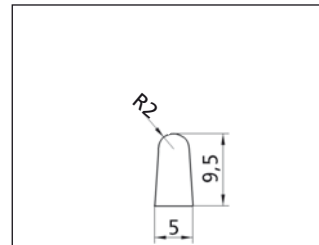

Depth: free
Profile No. 2.3.3.009.005

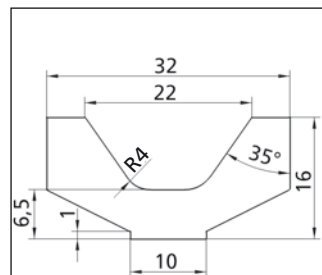

Depth: 15 mm
Profile No. 2.3.3.016.032

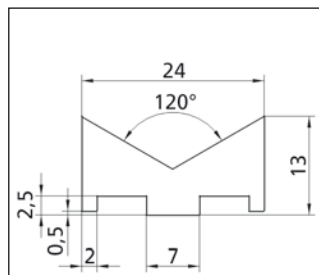

Depth: 15 mm
Profile No. 2.3.3.013.024

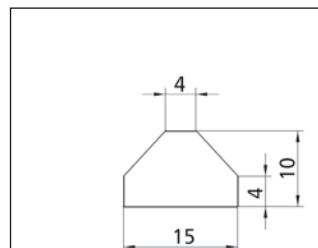

Depth: 35 mm
Profile No. 2.3.3.015.010

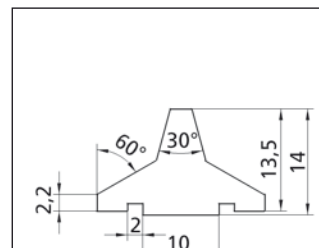

Depth: 170 mm
Profile No. 2.3.3.014.022

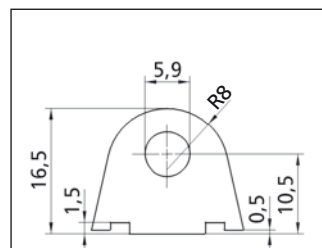

Depth: 15 mm
Profile No. 2.3.3.016.020

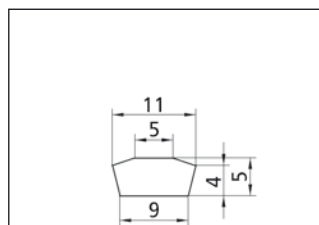

Depth: 25,4 mm
Profile No. 2.3.3.011.005

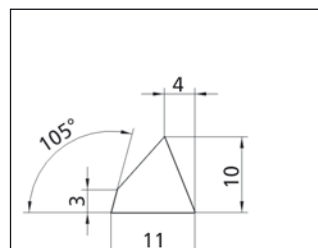

Depth: 98 mm
Profile No. 2.3.3.011.010

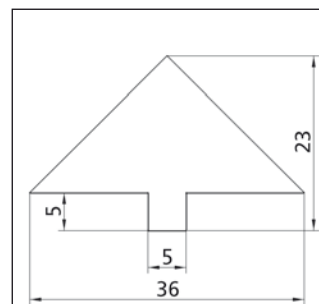

Depth: 100 mm
Profile No. 2.3.3.023.036

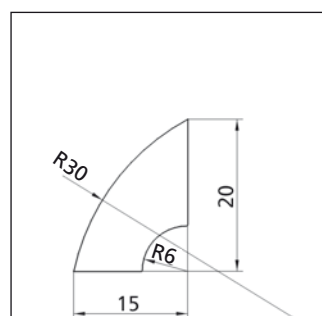

Depth: 100 mm
Profile No. 2.3.3.020.015

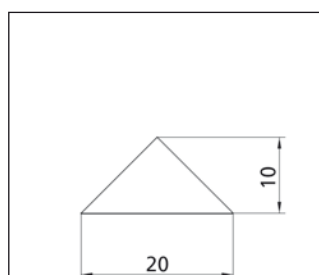

Depth: 100 mm
Profile No. 2.3.3.020.010

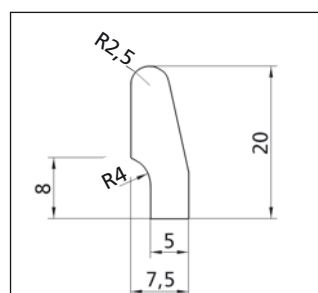

Depth: 70 mm
Profile No. 2.3.3.007.020

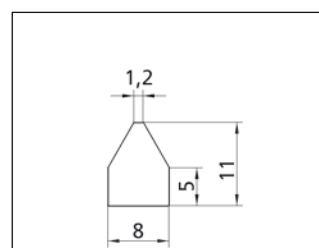

Depth: 10 mm
Profile No. 2.3.3.008.011

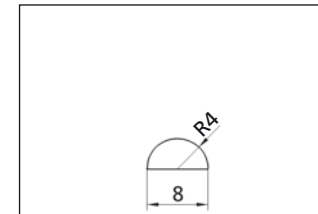

Depth: 100 mm
Profile No. 2.3.1.008.004

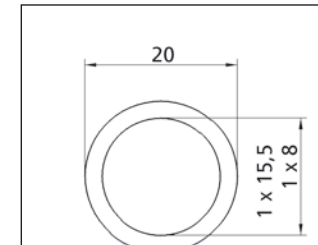

Depth: 50 mm
Profile No. 2.3.1.015.020

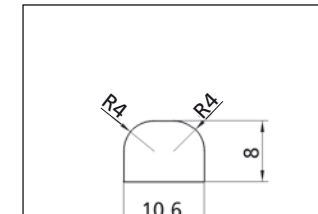

Depth: 100 mm
Profile No. 2.3.2.008.010

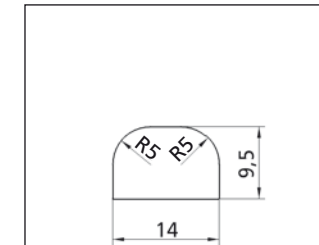

Depth: 64 and 100 mm
Profile No. 2.3.2.009.014

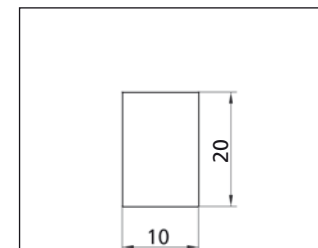

Depth: 100 mm
Profile No. 2.3.2.010.020

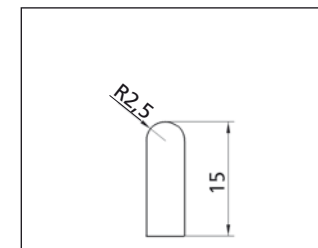

Depth: 195 mm
Profile No. 2.3.2.015.005

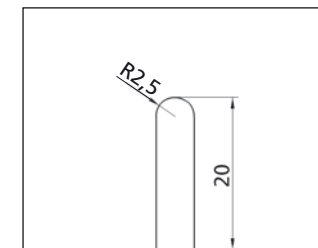

Depth: 100 mm
Profile No. 2.3.2.020.005

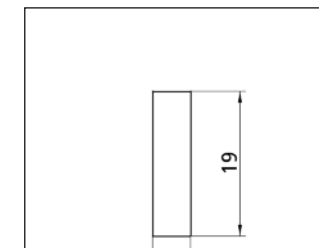

Depth: 64 mm
Profile No. 2.3.2.019.005

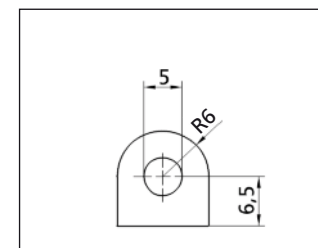

Depth: 50 mm
Profile No. 2.3.2.012.012

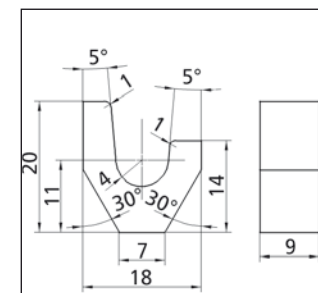

Profile No. 2.3.2.018.020

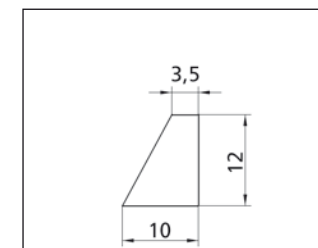

Depth: 130 mm
Profile No. 2.3.2.010.012

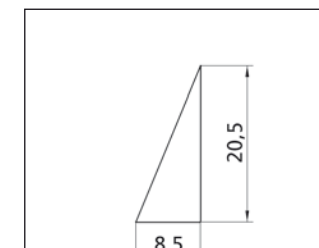

Depth: 100 mm
Profile No. 2.3.2.008.020

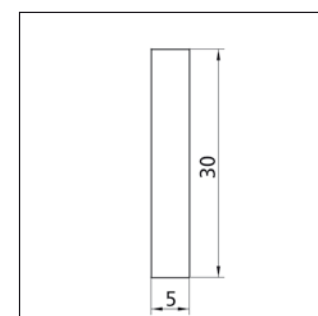

Depth: 100 mm
Profile No. 2.3.2.030.005

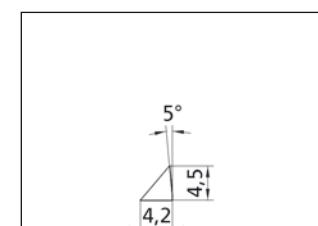

Depth: 101,6 mm
Profile No. 2.3.2.004.004

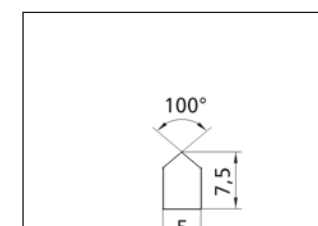

Depth: 100 mm
Profile No. 2.3.2.005.007

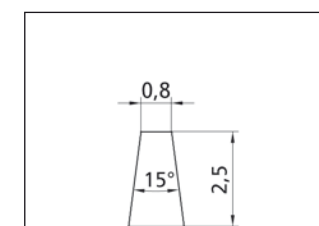

Depth: 64 mm
Profile No. 2.3.2.001.002

A system with many possibilities

The high-strength and removable profile attachment is based on the ATN system. The profiles are attached using screws in inset troughs, which can be used in the tooth by means of subsequent milling of individual belt teeth. The load on the connection is therefore not distributed to the individual inserts like in the ATN system, but rather across the entire width of the tooth. With this type of connection, the range of uses for ATN timing belts extends to areas that previously could not be realised due to an increased burden on the profile.

Another advantage of this connection is the ability to apply the ATN principle to other types of timing belts. Type AT10 and AT20 BRECOFLEX® and BRECO® timing belts can therefore be fitted with screwed on profiles after appropriate processing, so even these “traditional” conveyor belts can virtually achieve the flexibility of the ATN system.



Tooth processing at ATN20



Profile connection at ATN20 / AT20

Available insert trough widths	Number of threads
32 (only available in VA)	2
50	2
75	3

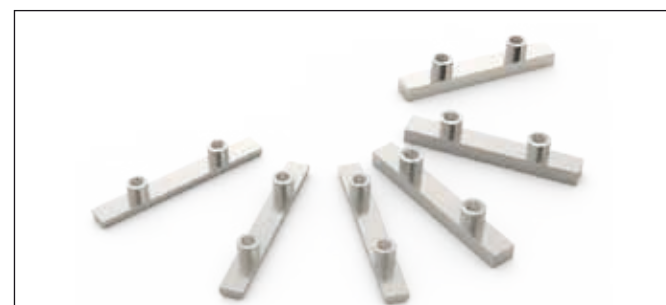

Insert trough ATN/AT10 VA / insert trough ATN/AT20 VA
(The insert troughs are (in some cases) also available in brass).

Suitable screw types for brass insert troughs

Allen screws according to DIN 7984 (galvanised) with hexagonal socket and low head (batch size 500 units)

Belt type	Screw type	Screw length	D	H
ATN10 / AT10	M4x8	8 mm	7,0	2,8
	M4x12	12 mm	7,0	2,8
	M4x16	16 mm	7,0	2,8
ATN20 / AT20	M5x12	12 mm	8,5	3,5
	M5x16	16 mm	8,5	3,5
	M5x20	20 mm	8,5	3,5



Allen screws according to DIN 7984 (galvanised)

Suitable screw types for VA insert troughs

Allen screws according to DIN 7984 (VA, material number 1.4301) with hexagonal socket and low head (batch size 500 units)

Belt type	Screw type	Screw length	D	H
ATN10 / AT10	M4x8	8 mm	7,0	2,8
	M4x12	12 mm	7,0	2,8
	M4x16	16 mm	7,0	2,8
ATN20 / AT20	M5x12	12 mm	8,5	3,5
	M5x16	16 mm	8,5	3,5
	M5x20	20 mm	8,5	3,5



Allen screws according to DIN 7984 (VA)

Ordering information

The current order designation for the belt types is to be used when ordering. The pitch distances of the belt teeth to be processed must be specified. The insert troughs are available in brass (MS) and stainless steel (VA). Please also use the order designation given here. The screws to be used correspond to the types offered for the ATN system.

Examples:

BRECO® TIMING BELT 75 ATN20 / 5600 V
Transverse milling insert trough ATN/AT20,
Pitch distance 80 mm
Insert trough 75 ATN/AT20 MS, number of units 70
Specification of screw type according to table (optional)

BRECOFLEX® TIMING BELT 50 AT10 / 6800 TPUFD1
Transverse milling insert trough ATN/AT10,
Pitch distance 200 mm
Insert trough 50 ATN/AT10 VA, number of units 34
Specification of screw type according to table (optional)

Timing belt guided by support rails

BRECO® and BRECOFLEX® timing belts have excelled in their use for transportation in many different areas. The belt material polyurethane has beneficial properties with regard to wear and abrasion. This is particularly beneficial when support rails are used (maximum belt speed 1 m/s). Support rails prevent the timing belt from shifting from the burden of the transported goods.

Support rails can be used with or without lateral guides. Support rails without lateral guides are preferable when no great lateral forces act on the conveyor belt. If lateral forces occur, support rails with lateral guides should be used.

To prevent abrasion, the timing belt must run through the middle of these lateral guides. It is therefore essential that the support rails are set up accordingly with infeed chamfers.

The following applies to the widths B' and b :

B' : There must be a minimum clearance of 0.5 mm between the maximum dimension b and the minimum dimension B' .

b : Depending on the required accuracy, the tolerance of the belt width can be reduced.

Material

We recommend using a low-friction and abrasion-resistant material such as low-pressure polyethylene. The sliding friction value between standard polyurethane and low-pressure polyethylene is between $\mu=0.3$ and $\mu=0.8$, depending on the material specification of the polyethylene used. We recommend always checking that the material is suitable for the intended use with the supplier of the low-pressure polyethylene.

Other possible combinations:

- Steel with bright surface, sanded if necessary, and polyurethane timing belt with polyamide coating (PAZ/PAR): $\mu=0.2$
- Surface-hardened bright aluminium and polyurethane timing belt with polyamide coating (PAZ/PAR): $\mu=0.2 \dots 0.3$

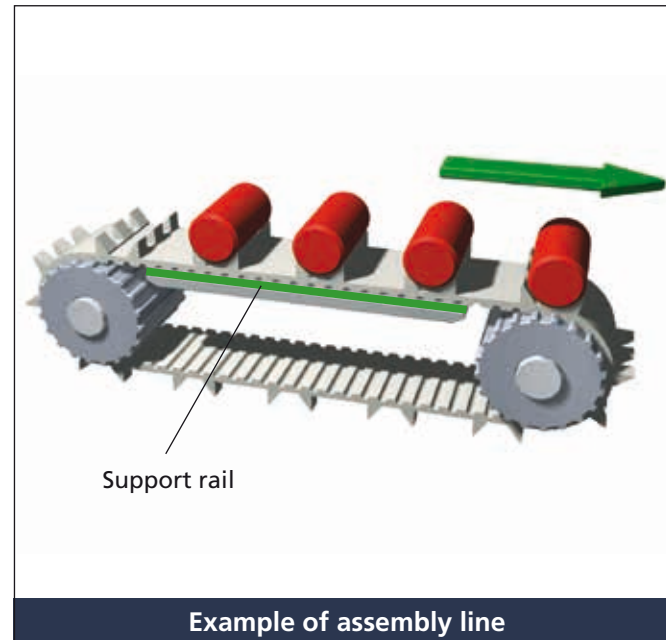

Example of assembly line

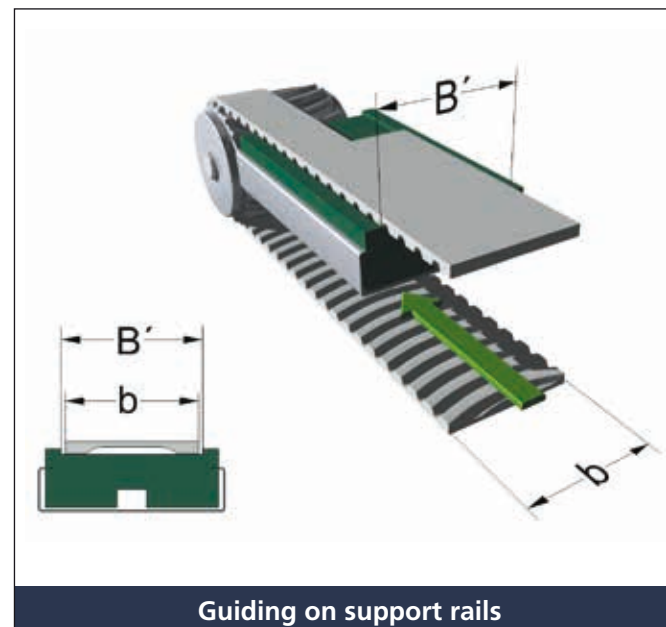

Guiding on support rails

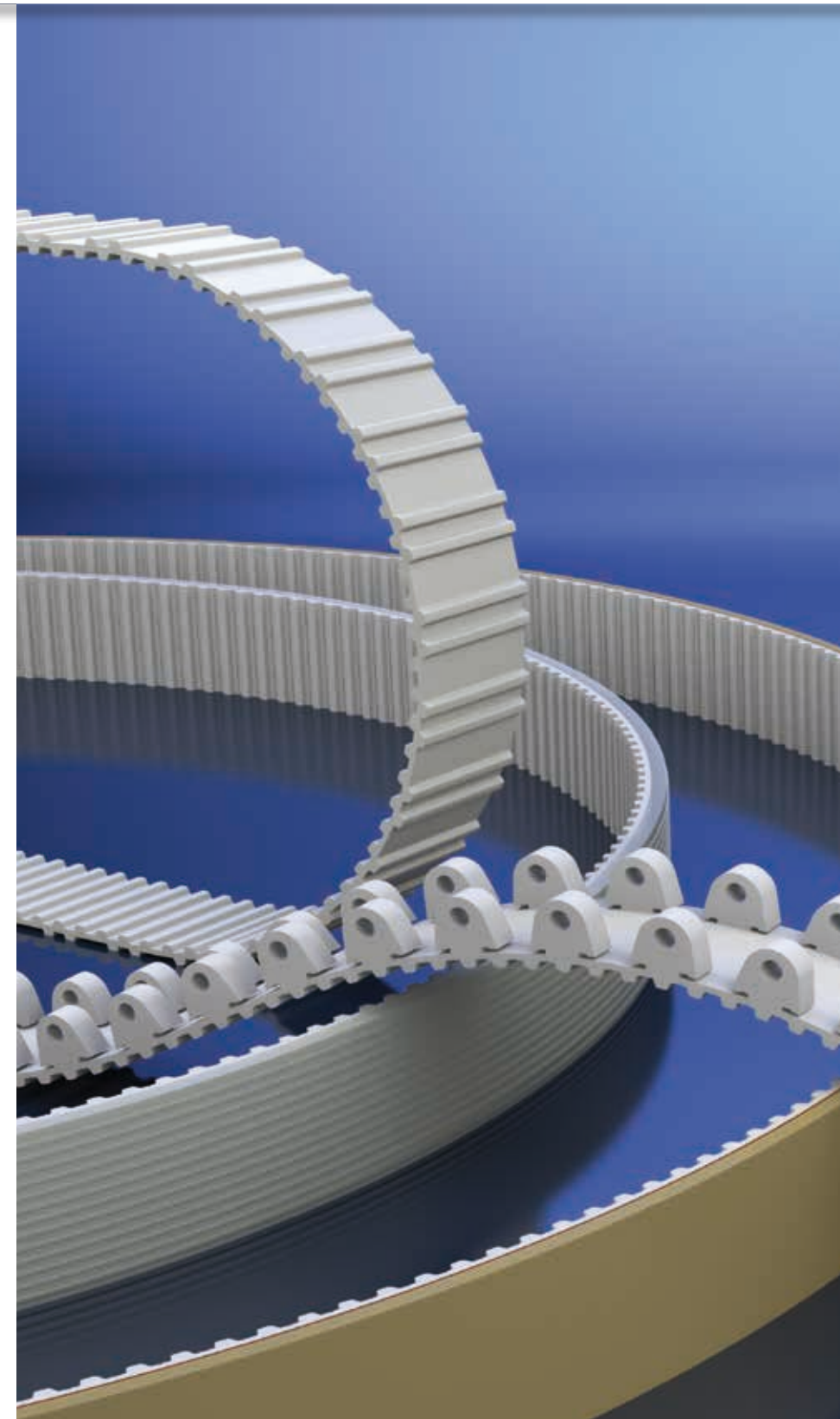

Anton Klocke
Antriebstechnik GmbH
 Senner Straße 151
 D-33659 Bielefeld
 phone: +49 521 950 05-01
 fax: +49 521 950 05-11
 www.klocke-antrieb.de
 info@klocke-antrieb.de



Germany

REIFF Technische Produkte GmbH
 Tübinger Straße 2-6
 D-72762 Reutlingen
 phone: +49 712 132 3-0
 fax: +49 712 132 3-318
 www.reiff-tp.de
 zahnriemen@reiff-gmbh.de



Germany

Wilhelm Herm. Müller GmbH & Co. KG
 Heinrich-Nordhoff-Ring 14
 D-30826 Garbsen
 phone: +49 513 145 22-0
 fax: +49 513 145 22-110
 www.whm.net
 info@whm.net



Germany

W. H. MÜLLER s.r.o.
 Pražákova 39
 CZ-61900 Brno
 phone: +420 543 211 008
 phone: +420 543 212 343
 fax: +420 541 217 468
 www.whm.cz
 whm@whm.cz



Czech Republic

Wilhelm Herm. Müller
 Polska Sp. z o.o.
 ul. Solna 20
 PL-85-862 Bydgoszcz
 phone: +48 523 490 715
 fax: +48 523 490 075
 www.whm.pl
 whm@whm.pl



Poland

Walter Rothermundt GmbH & Co. KG
 Am Tannenbaum 2
 D-41066 Mönchengladbach
 phone: +49 216 169 462-0
 fax: +49 216 166 446 9
 www.rothermundt.de
 info@rothermundt.de



Germany

Roth GmbH & Co. KG
 Andernacher Straße 14
 D-90411 Nürnberg
 phone: +49 911 995 21-0
 fax: +49 911 995 21-70
 www.roth-ing.de
 info@roth-ing.de



Germany

Aratron AB
 Smidesvägen 4-8
 SE-17141 Solna
 phone: +46 840 416 00
 fax: +46 898 428 1
 www.aratron.se
 info@aratron.se



Sweden

ARATRON AS
 Postboks 214 Holmlia
 N-1204 Oslo
 phone: +47 231 916 60
 fax: +47 231 916 61
 www.aratron.no
 firmapost@aratron.no



Norway

Movetec Oy
 Hannuksentie 1
 FIN-02270 Espoo
 phone: +35 895 259 230
 fax: +35 895 259 233 3
 www.movetec.fi
 info@movetec.fi



Finland

BONDY LMT A/S
 Hassellunden 14
 DK-2765 Smørum
 phone: +45 701 514 14
 fax: +45 446 414 16
 www.bondy.dk
 info@bondy.dk



Denmark

Hilger u. Kern GmbH
Antriebstechnik
 Käfertaler Straße 253
 D-68167 Mannheim
 phone: +49 621 370 5-0
 fax: +49 621 370 5-403
 www.hilger-kern.com
 antriebstechnik@hilger-kern.de



Germany

Haberkorn GmbH
 Modecenterstraße 7
 A-1030 Wien
 phone: +43 174 074-0
 fax: +43 174 074-99
 www.haberkorn.com
 info.wien@haberkorn.com



Austria

Dinámica Distribuciones S.A.
 Ctra. No. II, km 592,6
 E-08740 S. Andreu de la Barca
 phone: +34 936 533 500
 fax: +34 936 533 508
 www.dinamica.net
 dinamica@dinamica.net



Spain

BRECOflex Co., L.L.C.
 222 Industrial Way West
 USA-Eatontown, NJ 07724
 phone: +1 732 460-9 500
 fax: +1 732 542-6 725
 www.brecoflex.com
 info@brecoflex.com



USA

Binder Magnetic
 1, Allee des Barbanniers
 F-92632 Gennevilliers-Cedex
 phone: +33 146 138 080
 fax: +33 146 138 099
 www.binder-magnetic.com
 info@binder-magnetic.fr



France / Belgium

Transmission Developments Co. (G.B.) LTD
 Dawkins Road, Hamworthy
 GB-Poole Dorset BH15 4HF
 phone: +44 120 267 555 5
 fax: +44 120 267 746 6
 www.transdev.co.uk
 sales@transdev.co.uk



Great Britain



Distribution partner

BRECO insists on high quality not only in its manufacturing processes but also in the standard of its advice and service in everything to do with polyurethane timing belt technology. Our distribution partners are all specialists in this field who themselves offer first-class customer service.

BRECO is a member of Mulco Europe EWIV, a European Economic Interest Grouping (EEIG). All the members of this group are considered pioneers in the field of polyurethane timing belt technology. The trust which has evolved over many years and the intensive cooperation have been and will continue to be the basis for innovative power transmission solutions in mechanical engineering in general.

BRECO® and BRECOFLEX® timing belts - staying safely on the move.

Available product catalogues - for every application the right product

BRECO® and BRECOFLEX® timing belts

- General information (application and calculation notes)
- Endless timing belts (BRECOFLEX®)
- Open length timing belts (BRECO® M)
- Endless joined timing belts (BRECO® V)
- Timing belt lock for AT10, T10

ATN-System - BRECO® timing belts for transport technology

- General information about the ATN system (application information and notes on calculations)
- ATN timing belts
- ATN timing belt lock
- ATN standard profile connection
- ATN profiles
- ATN components

BRECO® and BRECOFLEX® flat belts

- General information
- Endless flat belts (BRECOFLEX®)
- Open length timing belts (BRECO® M)
- Open length flat belts (BRECO® M)
- Endless joined flat belts (BRECO® V)
- Fastening elements

Finishing of timing belts

- Coatings for polyurethane timing belts
- Mechanical rework of coatings
- Mechanical rework of timing belts
- High strength profile connection
- Welded-on profiles

Components

- General information
- Timing pulleys
- Synchronising shafts
- Synchronising pulleys with tensioners
- Tension rollers
- BRECO® fix-clamping elements

BRECObasic®-timing belts

- Product range
- Coatings for BRECObasic® timing belts

BRECOprotect®-timing belts

- Product range

Further information about:

- Sales partners
- New products and developments
- Available catalogues can be found at www.breco.de

Warranty

All information has been compiled with the utmost care and attention and reflects the current state of knowledge. However, we would like to particularly draw your attention to the fact that all technical data is quoted subject to tolerances and must not be interpreted as a guaranteed delivery specification. We reserve the right to make technical changes as part of our continuous product development process.



BRECO® and BRECOFLEX® are registered trademarks of BRECO Antriebstechnik Breher GmbH & Co. KG.

© 2013 BRECO Antriebstechnik Breher GmbH & Co. KG

All rights withheld.
No parts of this catalogue may be reproduced.
Printed in Germany, engl. version 18/2013/1860

Keeping things moving!



This company positioning confronts
BRECO Antriebstechnik Breher GmbH & Co. KG,
manufacturer of BRECO® and BRECOFLEX® timing belts,
with new great challenges, which are accepted with pleasure.

BRECO Antriebstechnik Breher GmbH & Co. KG
Kleiststr. 53 | D-32457 Porta Westfalica
phone: +49 5731 / 7670-0 | fax: +49 5731 / 7670-16
www.breco.de | info@breco.de

Find your responsible sales partner on
www.breco.de or www.mulco.de.

